

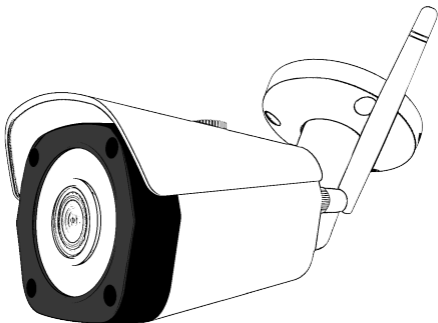

ClareVision Video  
Surveillance

## **Value Series Wi-Fi Fixed Lens Bullet Camera Installation Guide**



For Setting up cameras and complete user manuals, please scan these QR codes:

### Quick Start Guide



<https://bit.ly/3ndBOKO>

### User Manual



<https://bit.ly/3gEEj7s>

## Box Contents

- Camera and antenna
- 12VDC Power Supply
- Mounting template
- Mounting kit
- Accessory kit

## Required Equipment

- Phillips head screwdriver
- Power source: Ethernet cable
- Drill with 1/4" drill bit

## Cables

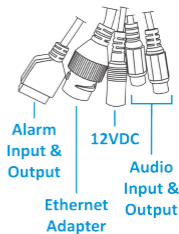

## Inspection

Ensure that the device is in good condition and all the assembly parts are included.

- Make sure that all equipment is powered off during installation.
- Ensure the mounting surface is strong enough to withstand three times the weight of the camera and the mount.
- If the product does not function properly, please contact technical support. **Do not disassemble the camera for repair or maintenance.**



WARNING: This product can expose you to chemicals including cadmium, which which is known to the State of California to cause cancer. For more information, go to [www.p65warnings.ca.gov](http://www.p65warnings.ca.gov).

## Overview

Before installing, familiarize yourself with the parts of the camera. **Please note, the Wi-Fi Bullet camera does not support POE.**

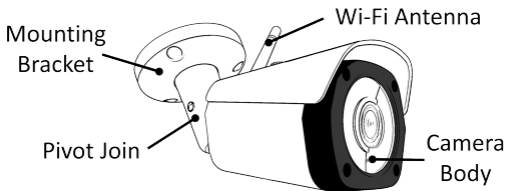

**NOTE:** Screw in the antenna into the antenna jack before installation.

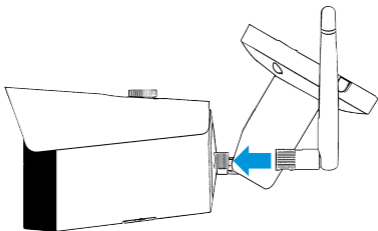

## Installation

**Before You Get Started:** You will need to physically connect the camera to the local area network using an Ethernet cable to configure the Wi-Fi.

A Wi-Fi signal strength of **-60dBm or greater** is required at the installation location to establish a reliable connection to the network.

1. Using an Ethernet cable, connect the camera to the home network via router, modem, or switch.

Power up the camera using the included 12VDC power supply.

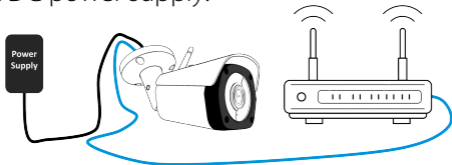

## Installation

2. Access the camera web console using the IP Address. You can use the IP Search Tool to discover the camera IP address. Download the tool here: **<https://bit.ly/3En7jJ7>**

3. Input the default username (**admin**) and password (**first six characters of the UUID**). Change the password when prompted.

4. Connect the camera to the desired 2.4GHz network using the Web Console, You can add the network by navigating to: **Configuration > Network > Wi-Fi**.

Select the desired Wi-Fi SSID and input the password. Tap **Save** once completed.

5. Check and update the firmware: **Configuration > System Configuration > Maintenance > Check Current Version**.

## Installation

6. Check to make sure you are able to discover and add the Wi-Fi camera using the ClareVision App (iOS or Android) when on the local area network.

7. At the desired installation location, check the Wi-Fi signal strength to ensure it is **-60dBm or greater** with the perimeter doors closed. If the signal is too low, you may need to boost the signal with a Wi-Fi range extender or wireless access point.

You can check the Wi-Fi signal strength using a Wi-Fi analyzer app such as:

- Wifi Analyzer app for Android
- AirPort Utility Tool for iOS

## Installation

8. Mount it to the desired location using the three mounting screws and anchors.

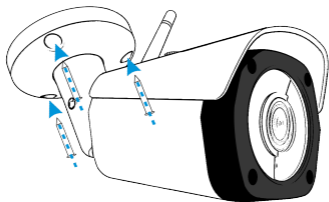

9. Using the provided hex key, loosen the machine screw on the mounting bracket.

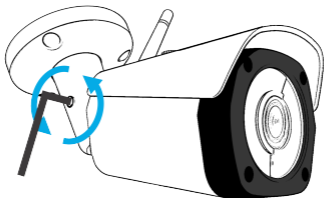



## Installation

10. Adjust the camera by panning, tilting, and rotating the camera body to the desired viewing angle.

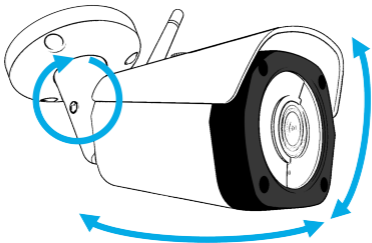

11. Tighten the machine screw using the hex key until the camera body is secured firmly to the base.

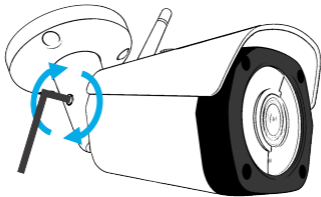

## Camera Setup & Default Password

**IMPORTANT NOTE:** The default camera setup password is the **FIRST 6 Characters of the UUID/SN.**

You will be prompted to change the password when setting up the camera. Please refer to the Quick Start Guide for complete setup instructions or by visiting:  
**<https://bit.ly/3ndBOKO>**

## Support

### **For additional help:**

Integrator/Dealer Support:

**Phone:** 941.404.1072

**Email:** [claresupport@clarecontrols.com](mailto:claresupport@clarecontrols.com)

For more information, instructional videos, or support documentation, visit our Help Center and view your item's product page:

**<https://www.clarecontrols.com/helpcenter>**

## Contact Information

### **Clare Controls, LLC.**

7519 Pennsylvania Ave, Suite 104

Sarasota, FL 34243

**General:** 941.328.3991

**Fax:** 941.870.9646

[www.clarecontrols.com](http://www.clarecontrols.com)

## Warranty Information

Clare Controls offers a two (2) year limited warranty on original Clare Controls components, from the date of shipment from Clare Controls. To view complete limited warranty details, including limitations and exclusions, please visit:

[www.clarecontrols.com/warranty](http://www.clarecontrols.com/warranty)

## Camera Information

Please provide this guide to the customer and notate the camera installation location and new camera password. This guide includes important camera details.

Camera Password: \_\_\_\_\_

Installation Location: \_\_\_\_\_

Camera Details:

