

4K/UHD Dual-Distance 8x8 HDMI to HDBaseT Matrix Switcher with PoE

AT-UHD-PRO3-88M

User Manual



Please check <http://www.atlona.com/UHD-PRO3-88M.html> for the most recent **firmware update** or **manual**.

Table of Contents

1. Introduction	3
2. Package Contents	3
3. Features	3
4. Before You Start	3
5. Panel Descriptions	
• Front Panel	4
• Back Panel	5
6. Rack Mounting	5
7. Category Cable	6
8. Captive Screw Audio	7
9. Connection Diagram	8
10. Button Set Up	9-12
11. WebGUI	13-20
12. RS-232	21-23
13. IR Remote Control	23
14. Captive Screw	24
15. Specifications	25
16. Safety Information	26
17. Warranty	27-28
18. Atlona Product Registration	28

Introduction

The 4K/UHD Dual-Distance 8x8 HDMI to HDBaseT Matrix Switcher with PoE is a multi zone switcher with long distance and extended distance ports, multiple control options, supports HDCP 2.2, and multi-channel audio up to Dolby Atmos.

Package Contents

- 1 x AT-UHD-PRO3-88M
- 14 x 4 pin captive screw female connector
(4 x IR IN, 4 x IR OUT, 6 x Audio OUT)
- 1 x 5 pin captive screw female connector - IR (2 pin), RS-232 (3 pin)
- 1 x IEC C13 power cable
- 1 x IR Remote control
- 1 x Pair of rack mount ears
- 1 x User Manual

Features

- Dual-distance HDBaseT ports for up to 100 meters (328 feet)
- Two HDMI outputs which can be set to mirror or matrix mode
- PoE (Power over Ethernet) to power up to eight compatible PoE EX series receivers
(Ex. AT-UHD-EX-100CE-RX or AT-UHD-EX-70C-RX)
- EDID learning for up to 10 video displays
- Built in internal EDID mode provides 12 unique EDIDs to ensure compatibility
- Multiple control options such as RS-232, IR, TCP/IP, WebGUI, and front panel
- 2Ch audio de-embedding through captive screw ports
- Independent zone volume control, mute, and 5 band EQ for captive screw audio outputs
- HDCP 2.2 compliant
- Multi-channel audio pass through up to Dolby Digital Plus, Dolby TrueHD, DTS-HD Master Audio, and Dolby Atmos
- Supports digital audio up to 24-bit, 192 kHz
- Internal international power supply

Before You Start

- Make sure when connecting a category cable a 568B termination method is used. See page 6 for more details.
- Use a component surge suppressor with line conditioning for best results.

Note: Atlona's warranty does not cover damage due to electrical disturbances. A component surge suppressor with line conditioning is highly suggested, especially in areas with electrical storms.

Panel Description

Front Panel

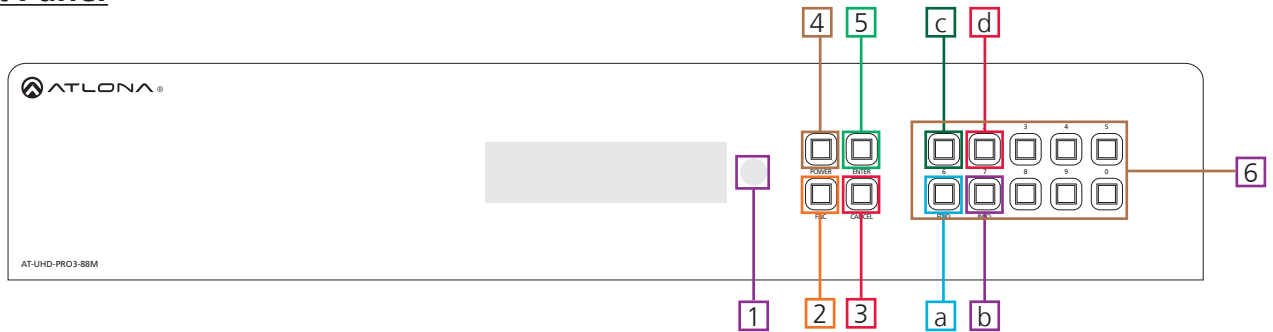

1. IR Receiver Window - Receives the signal from the included IR Hand Held Remote Control or 3rd party controller
2. Function (FNC) Button - Select for command options. (blue backlight when selected)
 - a. **EDID:** Save/Load EDIDs to individual inputs
 - b. **INFO:** Displays the firmware, IP, and MAC address
 - c. **1:** Save a single input to all the outputs with this function
 - d. **2:** View additional matrix and output RS-232 baud information
3. Cancel Button - Within the function menu use this button to go back one screen or to return to the home screen

Note: You cannot power off or change functions unless you return to the home screen

4. Power Button - Cycles the power between On (blue backlight) or Standby (red backlight) mode
5. Enter Button - Use to view current status for inputs and outputs or to confirm a command
6. Number buttons - Use these buttons to select input and output paths or use with the function button to change matrix settings

Back Panel

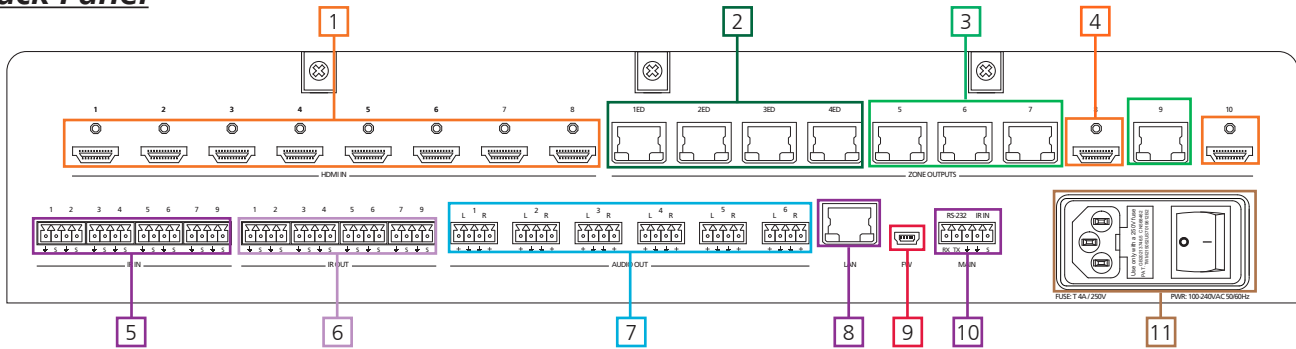

1. HDMI Input - Connect HDMI sources to these ports
Ex. DVD players, Blu-ray players, computers, game consoles, etc
2. Extended distance HDBaseT ports - Connect to extended distance EX receivers for pass through of PoE, control, and A/V signals. **Ex.** AT-UHD-EX-100CE-RX
3. Long distance HDBaseT ports - Connect to long distance EX receivers for pass through of PoE, control, and A/V signals. **Ex.** AT-UHD-EX-70C-RX
4. HDMI outputs - Mirror to provide a local output for HD audio routing to an AVR, or matrix the ports to provide a local video output for in room displays or an HDBaseT extender set
Ex. AT-UHD-EX-100CE-KIT
5. IR IN - Use with a 3rd party IR control box to extend IR control commands to video displays over category cable
6. IR OUT - Connect IR emitter here for controlling sources
7. Audio out - Captive screw analog audio loop outs for use with a sound system or multi-channel zone amplifier
8. LAN port - Connect to a network for TCP/IP, WebGUI and firmware updates
9. FW port - USB not enabled at this time for future functionality
10. Main control - Connect IR or RS-232 control system to the matrix
11. Internal power supply - Connect included IEC C13 power cable from here to a power outlet.

Rack Mounting

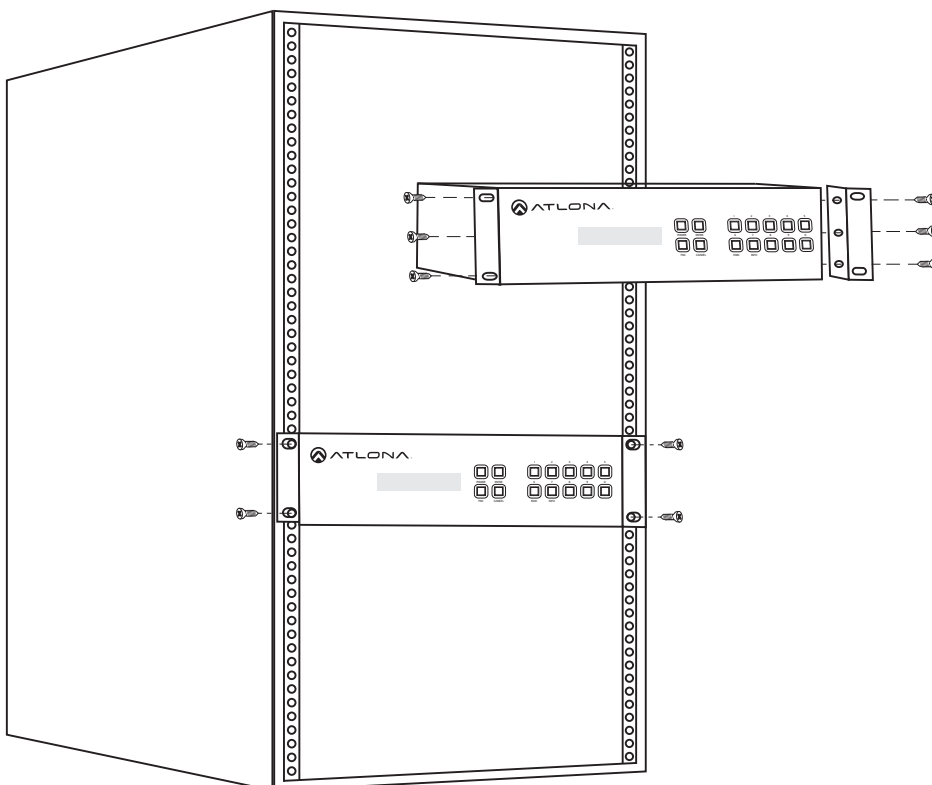

To rack mount the UHD-PRO3 unit: use the rack mount ears, the 6 screws from the sides of the UHD-PRO3, and 4 rack screws.

To affix the rack mount ears, remove the three screws on each side of the UHD-PRO3 and affix the rack ears to the UHD-PRO3 (as shown in the picture to the left).

Place the UHD-PRO3 in the rack, lining the holes in the rack ears with the holes in the rack. Once placed, use the rack screws to keep the unit in place. (as shown in the picture to the left).

Note: Increase the air flow as needed to maintain the recommended temperature inside the rack.

Note: Do not exceed maximum weight loads for the rack. Install heavier equipment in the lower part of the rack for stability.

Category Cable

For the category cables used in the installation of these products, please be sure to use a 568B termination as pictured below:

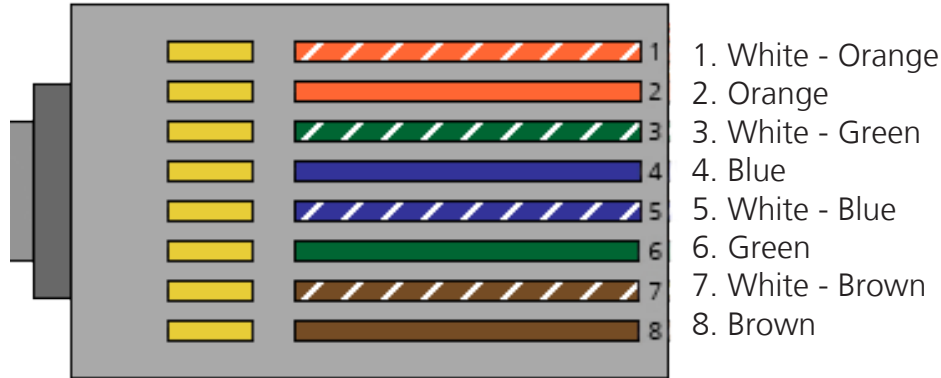

Use the table below to verify the best category cable for the installation.

Performance Rating		Type of LAN cable	
Wiring	Shielding	CAT5e/6	CAT6a/7
Solid	Shielded (STP/FTP)	***	****
	UnShielded (UTP)	**	N/A
Stranded - Patch cable (Not recommended)	Unshielded (UTP)	*	N/A
	Shielded (STP/FTP)	*	N/A
Termination		Please use EIA/TIA-568-B termination	

Important! 4K (UHD) signals are sensitive to cable quality and installation technique. It is recommended to use CAT6a/7 solid core cables for best results.

Note: For cable distances see the specifications on page 25

Connector

Connector type and size is very important to ensure extenders work correctly. Please use the matching cable type with the correct RJ45 connector.

CAT5e and CAT 6 cables should use only CAT5e RJ45 connectors

CAT6a cables should use only CAT6a connectors

CAT7 cables should use only CAT7 connectors

Using the wrong size of connectors may result in interference causing loss of signal.

Important! "EZ RJ45 connectors" are not recommended with HDBaseT extenders. Doing so may result in stray EMI/RFI signals to be picked up and interfere with audio and video transmission.

Analog Audio

A captive screw analog audio connector is provided to ensure a more reliable and secure connection. The captive screw connector supports unbalanced audio output.

Unbalanced audio connections use two wires for connection with consumer audio components.

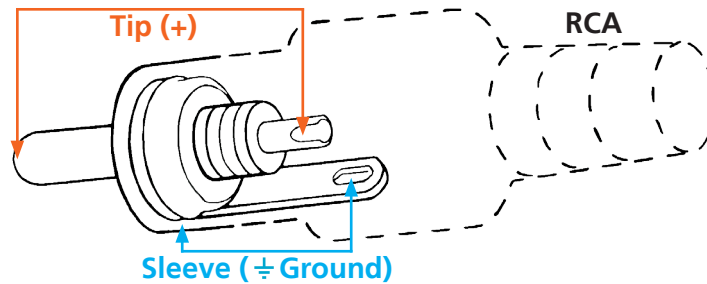

Note: Pin outs may vary, please refer to the audio device's manual to ensure a correct connection.

Important! When terminating cables, please ensure exposed adjacent wires do not touch. This may result in a short that can damage connected devices.

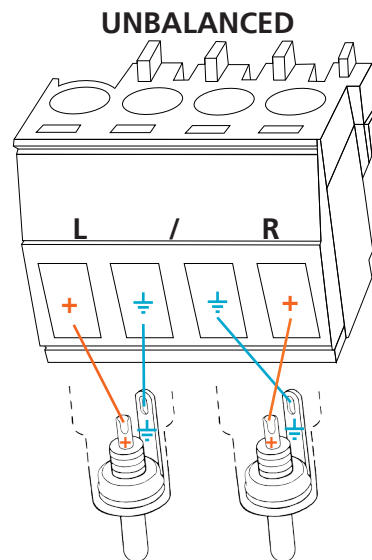

For an easier and time saving solution for analog audio, the optional Atlona Captive Screw Ready 2 Channel Unbalanced Audio Cable (AT-LC-CS-2CH-2M) features pre-stripped wires at one end and RCA connectors at the other end. Purchase these at <http://www.atlona.com>

To connect these, use the red wire in the right positive port, the white wire in the left positive port, and the black can be placed in either ground port.

Connection Diagram

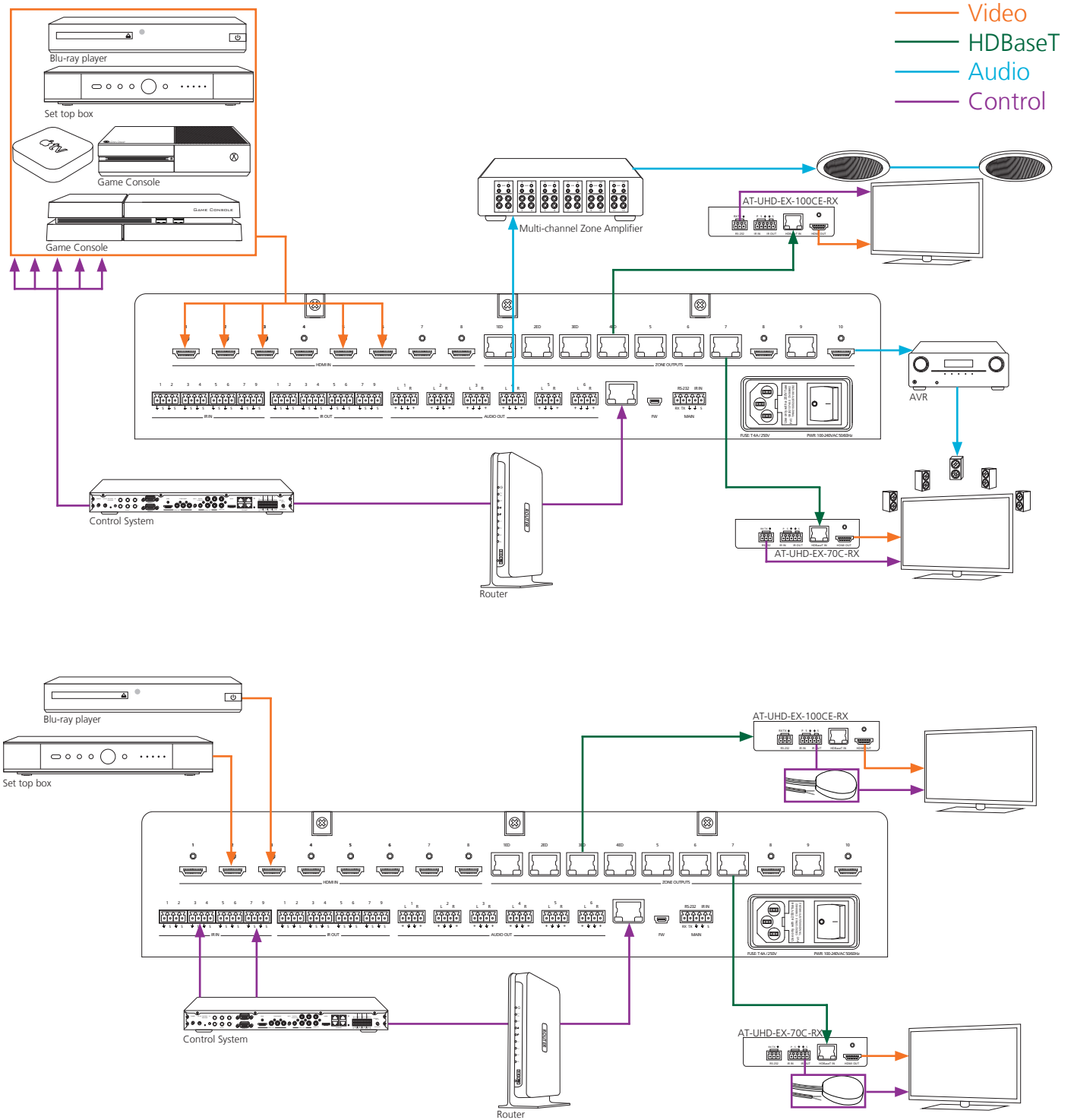

Matrix Front Panel Functions

The AT-UHD-PRO3-88M's front panel has 3 functions: I/O control, EDID, and matrix settings. The following sections go over step by step setup & control.

I/O Control

To **route** an input to an output

I.E. Input 1 to output 2

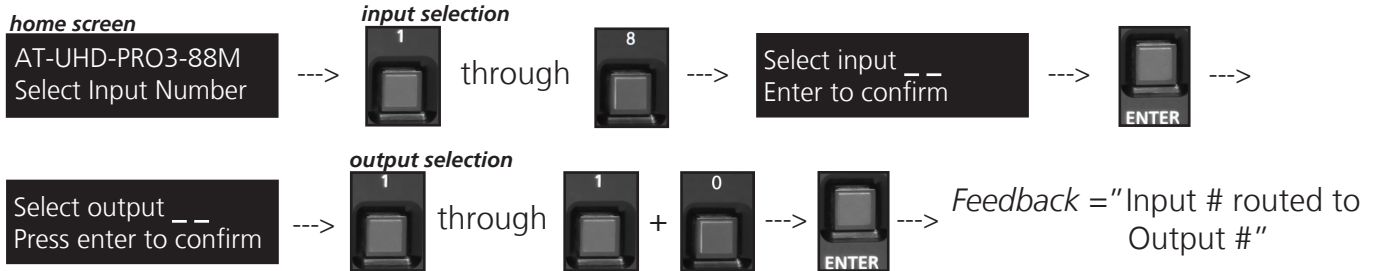

To **route** one input to all outputs

I.E. Input 1 to output 1 through 10

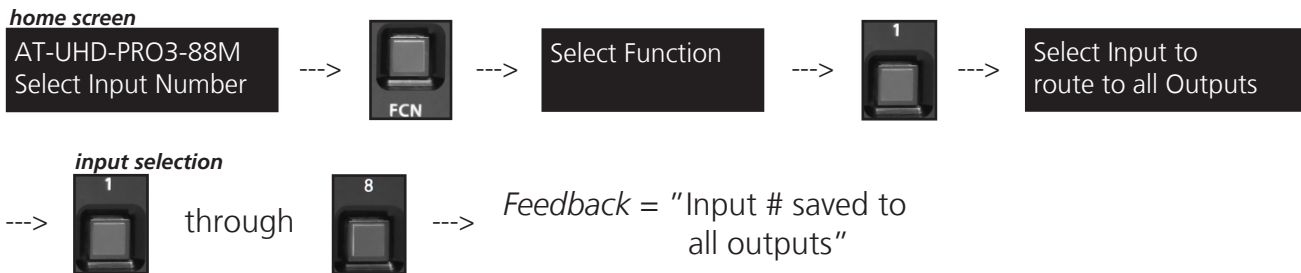

EDID Set Up

When the matrix is completely connected and turned on it will load the **default EDID**, which is the highest common native resolution of the connected devices. (i.e. In the diagram below the default would be 1080p with 2ch audio. **Multi-channel audio and 3D are not enabled on default mode, unless all devices support these features.**)

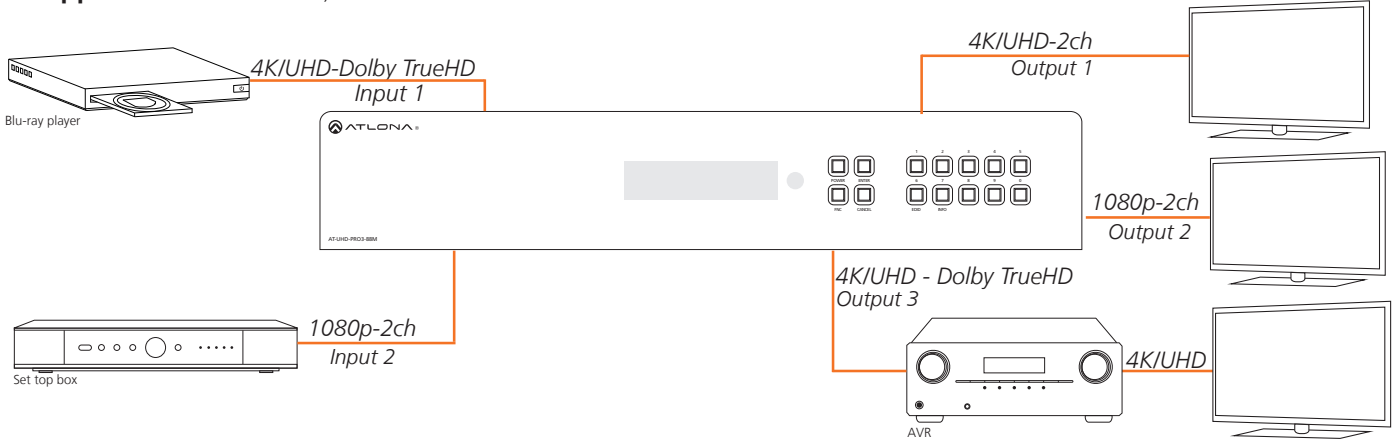

On default, all devices in the diagram will work at 1080p. If a device is not syncing or a different resolution is required, internal EDID or EDID copy and load should resolve these issues. The UHD-PRO3 can copy and store up to 10 EDIDs to memory.

Step 1: copy an EDID

Before an EDID can be loaded to an input, it must first be copied to the matrix's memory. Each display's EDID can be saved individually to one of the matrix's ten preset EDID memories.

home screen

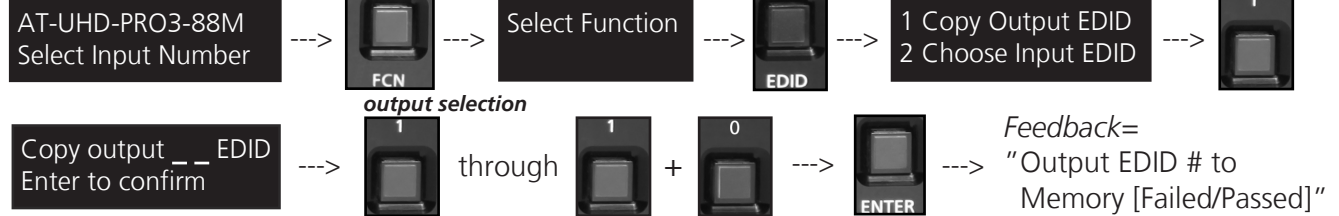

Step 2: load a copied EDID to an input

Once EDIDs have been copied to memory they can be loaded to a specific input.

Note: (refer to the diagram above) Using the EDID of output 3 with input 1 will enable 4K/UHD and Dolby TrueHD to pass. With these settings, output 2 will receive no audio or video and output 1 will receive no audio.

home screen

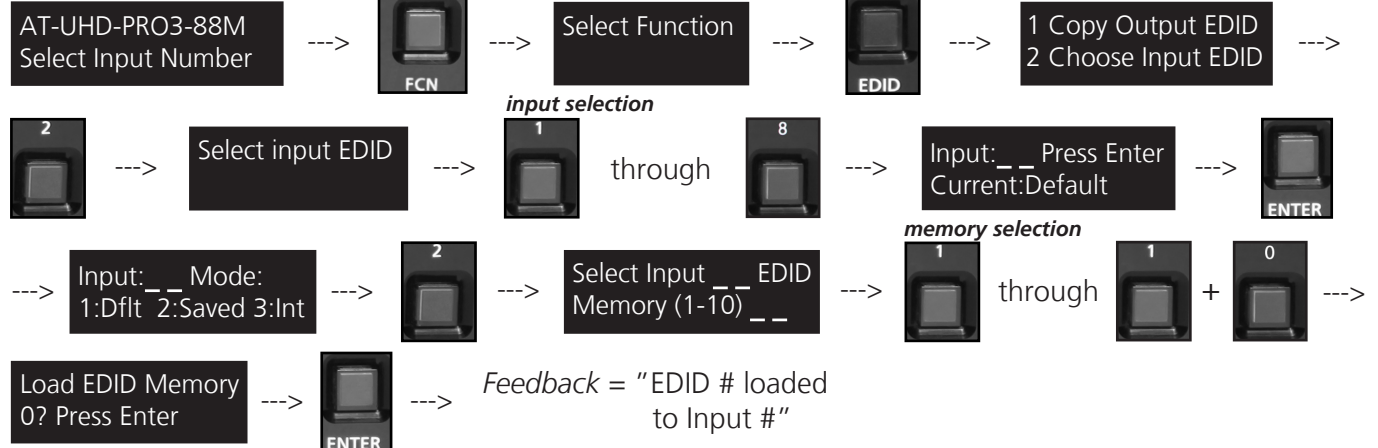

Step 3: Load an internal EDID to an input

If the first two steps don't produce the correct resolution or audio configuration, the twelve internal EDIDs should resolve the issue.

Internal EDID options

- EDID 1: 1080P 2CH audio
- EDID 2: 1080P HD multi-channel audio 7.1*
- EDID 3: 1080P Dolby Digital/DTS 5.1
- EDID 4: 1080P 3D 2CH audio
- EDID 5: 1080P 3D HD multi-channel audio 7.1*
- EDID 6: 1080P 3D Dolby Digital/DTS 5.1
- EDID 7: 720P 2CH audio
- EDID 8: 720P Dolby Digital/DTS 5.1
- EDID 9: 1280x800 RGB 2CH audio
- EDID 10: 1366x768 RGB 2CH audio
- EDID 11: 1080P DVI**
- EDID 12: 1280x800 DVI**
- EDID 13: 3840x2160 2CH audio
- EDID 14: 3840x2160 multi-channel audio 7.1*

Front panel display readout

- ATL 1080P 2CH
- ATL 1080P Multi CH
- ATL 1080P DD
- ATL 1080P 3D 2CH
- ATL 1080P 3D MultiCH
- ATL 1080P 3D DD
- ATL 720P 2CH
- ATL 720P DD
- ATL 1280x800 RGB 2CH
- ATL 1366x768 RGB 2CH
- ATL 1080P DVI
- ATL 1280x800 RGB DVI
- ATL UHD 2CH
- ATL UHD MultiCH

* Recommended EDID for AVR use

** Recommended EDID for DVI projectors use

home screen

AT-UHD-PRO3-88M
Select Input Number



Select Function



1 Copy Output EDID
2 Choose Input EDID



Select input EDID

input selection



through



Input: __ Press Enter
Current: Default



Input: __ Mode:
1:Dflt 2:Saved 3:Int



Int EDID __ + enter
ATL _____

Internal EDID selection



1 - Cycles through EDIDs in ascending order

2 - Cycles through EDIDs in descending order



Feedback = "Int EDID # saved to input #"

RS-232 and TCP/IP commands:

To access different EDIDs through RS-232 or TCP/IP, the following commands must be used.

Command	Feedback	Description
EDIDMSetX default	EDIDMSetX default	Sets the EDID of an input to the default EDID Ex. EDIDMset2 default - sets input 2 to default
EDIDMSetX saveY	EDIDMSetX saveY	Sets the EDID of an input to the previously saved EDID memory Ex. EDIDMset1 save3 - sets input 1 to EDID memory 3
EDIDMSetX intZ	EDIDMSetX intZ	Sets the EDID of an input to one of the internal EDIDs Ex. EDIDMset3 int6 - sets input 3 to the internal EDID - 1080p 3D Dolby Digital 5.1

Matrix Status

When installing or troubleshooting it's important to verify settings, or be able to come back to a project and see how it was set up. The AT-UHD-PRO3-88M matrix settings are viewable through the front panel display. View current I/O settings, firmware version, IP, MAC Address, and the RS-232 baud rates of not just the matrix but output zones as well.

View current I/O settings

home screen

AT-UHD-PRO3-88M
Select Input Number



O 1 2 3 4 5 6
| x x x x x x



O 7 8 9 10
| x x x x

View Firmware/Baud Rate settings

home screen

AT-UHD-PRO3-88M
Select Input Number



Select Function



AT-UHD-PRO3-88M
FW Ver: 0.X.XX



IP Address:
XXX.XXX.XXX.XXX

Press INFO to cycle through the IP Address, IP Port, and MAC Address



IP Port
23



MAC Address
B8:98:B0:03:0D:4C



TX Baud Rate
115200

EX. 115200, 9600, etc

Matrix Baud Rate



RX 01 Baud Rate
X X X X

Zone output baud rate



Press 2 to cycle through the baud rates of each output.

LAN

For convenience, the matrix comes with DHCP default on. This ensures the matrix IP will not override another device.

To find the matrix IP:

home screen

AT-UHD-PRO3-88M
Select Input Number

--->



--->

Select Function

--->



--->

AT-UHD-PRO3-88M
FW Ver: 0.3.XX

--->



--->

IP Address:
X.X.X.X
IP Address

EX. 192.168.000.200

Browser WebGUI

Atlona has created an easy to use WebGUI for changing settings and controlling the matrix.

To begin, plug a LAN cable into the matrix and your network router, then type the IP address of the matrix into a web browser (as seen below).

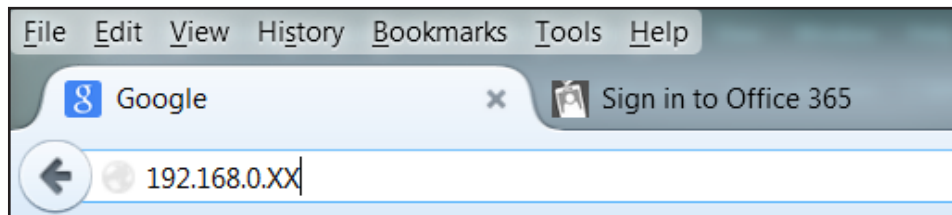

Important: If any stability issues are experienced, disable any anti-virus or firewall that may be interfering with network communication to the Matrix. Once set up is done and the matrix GUI is no longer being used, the firewall and anti-virus can be re-enabled.



Admin Login

User name

Password

A login screen will appear (this is the same log in for admin and general users). For the first log in (and future admin changes) the username is "root" and password is "Atlona".

Note: Admin username and password can be changed within the WebGUI (see page 16).

Home

- [Status](#)
- [Firmware](#)

Settings

- [Network](#)
- [Control](#)
- [Users](#)

Configuration

- [I/O](#)
- [Route Memory](#)
- [EDID](#)
- [HDCP](#)
- [Audio](#)
- [Logout](#)

System Information Download Log

Model	AT-UHD-PRO3-88M
UI Firmware	1.4.28
HDMI Firmware	1.4.25
FPGA Version	0.3
Hardware Version	1.0
MAC Address	B8:98:B0:03:0D:60
Serial Number	00000
Temperature	42°C --- 108°F
Operating Time	4/2/2015 (19:25:30)

Save System Settings

Load system settings

File Browse... Load

The home page will allow the user to see the general system information, download the matrix log, and save/load system settings. The information displayed will help figure out if the matrix is up to date, how long it has been running, and other key information.

The Download Log button is for Atlona Tech Support Team only. Tech Support may request the log be sent to them for more in depth troubleshooting.

Note: To save the log, press the “Download Log” button. The file will automatically save to the “download” folder.

Save System Settings will backup the current settings of: network, users, I/O labels, and the current I/O settings of the matrix. If the matrix requires a factory reset, the backed up settings can be loaded onto the matrix.

Note: To save the system settings, press the “Save System settings” button. The file will automatically save to the download folder. The file can be renamed (using a project name may make the file easier to find later) but the file extension should not be altered (altering the extension may corrupt or make the file unusable).

Note: To load the system settings, click the browse button on the WebGUI. Once the search folder displays, select the file and press the load button. A progress bar will display to make it easier to know when the upload is complete. If a restart is required, a prompt will display.

Home

- [Status](#)
- [Firmware](#)

Settings

- [Network](#)
- [Control](#)
- [Users](#)

Configuration

- [I/O](#)
- [Route Memory](#)
- [EDID](#)
- [HDCP](#)
- [Audio](#)
- [Logout](#)

Firmware Status

Matrix	
UI Firmware	1.4.36
HDMI	1.4.31
FP	1.4.20
FPGA Version	0.4
HDBaseT TX VS100	13090C10
HDBaseT TX VS10	23090C10

HDBaseT Receivers	
Out 1: Output_1	13090C00
Out 2: Output_2	13090C00
Out 3: Output_3	13090C00
Out 4: Output_4	23090C00
Out 5: Output_5	13090C00
Out 6: Output_6	13090C00
Out 7: Output_7	23090C00
Out 8: Output_8	HDMI Only
Out 9: Output_9	13090C00
Out 10: Output_10	HDMI Only

Firmware Update

Matrix

File No file selected.

HDBaseT Receiver

No file selected.

The firmware page displays the matrix, HDBaseT transmitter chips, and HDBaseT receivers firmware version and provides an easy way to update.

Download the most current firmware from <http://atlon.com/UHD-PRO3-88M.html>. Once the firmware is on the computer use the browse button to select the correct file. Press the update button and a progress bar will display. If a restart is required, the WebGUI will display a prompt.

Home

- [Status](#)
- [Firmware](#)

Settings

- [Network](#)
- [Control](#)
- [Users](#)

Configuration

- [I/O](#)
- [Route Memory](#)
- [EDID](#)
- [HDCP](#)
- [Audio](#)
- [Logout](#)

Network Settings IP Reset

DHCP ON OFF

IP Address

Subnet

Gateway

Telnet Port

HTTP Port

Login Mode ON OFF

The network page enables the matrix IP settings to be altered. If a static IP is required, then DHCP needs to be turned off. Once off, the settings will be available to change.

Login mode, when on, will request a password whenever a control device is connected to the matrix.

Home

- [Status](#)
- [Firmware](#)

Settings

- [Network](#)
- [Control](#)
- [Users](#)

Configuration

- [I/O](#)
- [Route Memory](#)
- [EDID](#)
- [HDCP](#)
- [Audio](#)
- [Logout](#)

Control Settings

Power: ON OFF

IR: ON OFF

Key Lock: ON OFF

Factory Default:

NTP Server:

Time zone:

No.	Baudrate
Matrix	<input type="text" value="115200"/>
Output 1: Output_1	<input type="text" value="19200"/>
Output 2: Output_2	<input type="text" value="19200"/>
Output 3: Output_3	<input type="text" value="19200"/>
Output 4: Output_4	<input type="text" value="19200"/>
Output 5: Output_5	<input type="text" value="19200"/>
Output 6: Output_6	<input type="text" value="19200"/>
Output 7: Output_7	<input type="text" value="19200"/>
Output 8: Output_8	HDMI Only
Output 9: Output_9	<input type="text" value="19200"/>
Output 10: Output_10	HDMI Only

The control page will allow simple functions to be changed. Turn the matrix on/off, IR front panel receiver window on/off, and front panel key lock on/off. The time zone and baud rates (for matrix and zone outputs) can be altered as well.

Home

- [Status](#)
- [Firmware](#)

Settings

- [Network](#)
- [Control](#)
- [Users](#)

Configuration

- [I/O](#)
- [Route Memory](#)
- [EDID](#)
- [HDCP](#)
- [Audio](#)
- [Logout](#)

Change user name and password

No.	Username	Password	Action
User 1	<input type="text"/>	<input type="text"/>	<input type="button" value="Add"/>
User 2	<input type="text"/>	<input type="text"/>	<input type="button" value="Add"/>
User 3	<input type="text"/>	<input type="text"/>	<input type="button" value="Add"/>

Change Admin Name and Password

Old username:	<input type="text"/>
Old password:	<input type="text"/>
New username:	<input type="text"/>
New password:	<input type="text"/>

The Users page allows non-admin users to be added or the admin username and password to be changed.

Only 3 non-admin users can be added. Type in the username and password to the fields and press add. Users will not have the ability to access this page.

Admin username and password (default username="root" and password="Atlona") can also be changed. Be sure to write this information down as admin is the only profile allowed to add/remove users.

Home

- Status
- Firmware

Settings

- Network
- Control
- Users

Configuration

- I/O
- Route Memory
- EDID
- HDCP
- Audio
- Logout

Input/ Output Selection
I/O Reset

Out 1: Output_1		In 1: Input_1
Out 2: Output_2		In 2: Input_2
Out 3: Output_3		In 3: Input_3
Out 4: Output_4		In 4: Input_4
Out 5: Output_5		In 5: Input_5
Out 6: Output_6		In 6: Input_6
Out 7: Output_7		In 7: Input_7
Out 8: Output_8	Mirror Mode <input type="button" value="Off"/>	In 7: Input_7
Out 9: Output_9		In 8: Input_8
Out 10: Output_10	Mirror Mode <input checked="" type="button" value="On"/>	Out 1: Output_1
Output "All"		None

Default Routing

Input Label

In 1: Input_1	<input style="width: 90%;" type="text"/>	<input type="button" value="Change"/>
---------------	--	---------------------------------------

Output Label

Out 1: Output_1	<input style="width: 90%;" type="text"/>	<input type="button" value="Change"/>
-----------------	--	---------------------------------------

Note: Default label is Input_X or Output_X. Labels will follow corresponding ports.
Ex. Input 6 will default to label Input_6

The I/O page makes an easy way to set up input and output routing and labeling.

The inputs and outputs have the option for labeling to help make routing and switching simpler. Label each input and output individually. Select what source or zone that is to be labeled, type the name in the box, and press change.

Note: Labels are limited to 16 characters and no spaces

I/O routing includes mirror mode for the HDMI ports.

Mirror Mode:

On - HDBaseT outputs are selectable from the drop down menu. The HDMI port will output the same audio and video of the selected HDBaseT output

Off - Any of the connected inputs are selectable from the drop down menu. The HDMI port will output audio and video from the source to a local display.

Home

- Status
- Firmware

Settings

- Network
- Control
- Users

Configuration

- I/O
- **Route Memory**
- EDID
- HDCP
- Audio
- Logout

Route Memory (this will not change the current I/O selection) Memory Reset

Preset select: M1: Preset_1 ▾

Out 1: Output_1		In 1: Input_1 ▾
Out 2: Output_2		In 2: Input_2 ▾
Out 3: Output_3		In 3: Input_3 ▾
Out 4: Output_4		In 4: Input_4 ▾
Out 5: Output_5		In 5: Input_5 ▾
Out 6: Output_6		In 6: Input_6 ▾
Out 7: Output_7		In 7: Input_7 ▾
Out 8: Output_8	Mirror Mode On ▾	In 8: Input_8 ▾
Out 9: Output_9	Mirror Mode On ▾	In 9: Output_9 ▾
Out 10: Output_10		

Save
Cancel

Memory label

M1: Preset_1 ▾ change

Memory Selection (This will change the current I/O selection)

M1: Preset_1 ▾ Select

The Route Memory page provides set up, labeling, and configuration of multiple preset memories for fast and easy control.

Set Up

- Select Route Memory # from the 'Preset Select' drop down menu
- Set the input/output routes
- Save to memory
- Label the route memory preset
- Repeat as needed until all route memories are saved

Note: Switching does not occur during the set up and labeling of route memory.

To apply route memory to the matrix: Select the route memory # from the memory selection drop down menu and press the 'Select' button.

atlona.com

18

Toll free: 1-877-536-3976
 Local: 1-408-962-0515

Home

- Status
- Firmware

Settings

- Network
- Control
- Users

Configuration

- I/O
- Route Memory
- EDID
- HDCP
- Audio
- Logout

EDID (Extended display identification data)
EDID Reset

Output	Output EDID	EDID Memory
1 : Output_1	SNY SONY TV *06	none
2 : Output_2	SAM SAMSUNG	none
3 : Output_3	SAM SAMSUNG	none
4 : Output_4	BNO BeoVision	none
5 : Output_5	GSM LG TV	none
6 : Output_6	SAM SAMSUNG	none
7 : Output_7		none
8 : Output_8	VIZ M320SL	none
9 : Output_9	SNY SONY TV *07	none
10 : Output_10	GSM LG TV	none

Save
Cancel

Input	EDID Selection
1 : Input_1	ATL UHD 2CH
2 : Input_2	ATL UHD 2CH
3 : Input_3	ATL UHD 2CH
4 : Input_4	ATL UHD 2CH
5 : Input_5	ATL UHD 2CH
6 : Input_6	ATL UHD 2CH
7 : Input_7	ATL UHD 2CH
8 : Input_8	ATL UHD 2CH

Save
Cancel

The EDID page is used for saving EDIDs, loading EDIDs, or using internal EDIDs on the input ports. Each output will have an individual EDID that can be saved to memory. The matrix has 10 available EDID memory presets. Each display EDID can be saved to the corresponding memory number.

Ex. Output 2 to EDID memory 2. Once saved, the EDIDs can be loaded to the input to ensure compatibility.

Internal EDIDs can also be loaded to inputs. There are 12 internal EDIDs. The list can be found on page 11.

Home

- Status
- Firmware

Settings

- Network
- Control
- Users

Configuration

- I/O
- Route Memory
- EDID
- HDCP
- Audio
- Logout

HDCP

Output Port	Status
1 : Output_1	Non-Compliant
2 : Output_2	Compliant 1.x
3 : Output_3	Compliant 1.x
4 : Output_4	Compliant 1.x
5 : Output_5	Compliant 2.2
6 : Output_6	Compliant 2.2
7 : Output_7	No Connection
8 : Output_8	Non-Compliant
9 : Output_9	Non-Compliant
10 : Output_10	Non-Compliant

The HDCP page provides a quick way to see whether a display is HDCP compliant or not and the version supported. This page will give multiple status readouts: No Connection, Compliant 1.X, Compliant 2.X, and Non-Compliant.

Home

- [Status](#)
- [Firmware](#)

Settings

- [Network](#)
- [Control](#)
- [Users](#)

Configuration

- [I/O](#)
- [Route Memory](#)
- [EDID](#)
- [HDCP](#)
- [Audio](#)
- [Logout](#)

Equalizer
[Audio Reset](#)

Output: 1: Output_1

0



63Hz

0



250Hz

0



1kHz

0



4kHz

0



8kHz

0 [Mute](#)

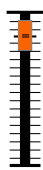

Volume

[Save](#)
[Cancel](#)

The audio page supports adjustment of 5 band EQ for the analog audio outputs ensuring the best audio performance for each zone. 5 band frequency options at 63Hz, 250Hz, 1kHz, 4kHz, and 8kHz as well as zone output volume and mute.

RS-232

Connection

RS-232 pin out will be determined by the RS-232 cable and will connect as Rx (receiver), Tx (transmitter), and \perp (ground). (See picture 1)

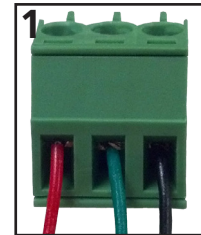
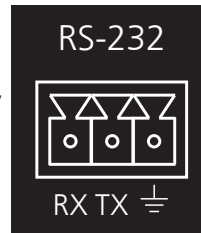

Wire color will differ by cable manufacturer.

RS-232 is often connected through a DB 9-pin to captive screw connector. The pins will have functions associated with them, some will be unassigned.

Note: Typical DB9 connectors use pin 2 for TX, pin 3 for RX, and pin 5 for ground. On some devices functions of pins 2 and 3 are reversed.

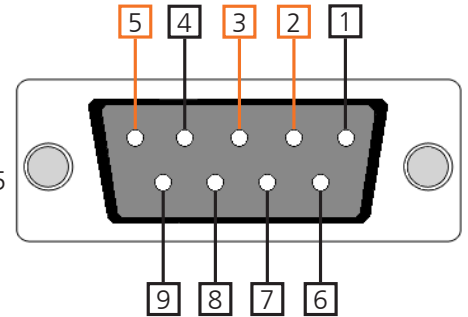

Set Up

To set up the RS-232 hyperterminal (if not using 3rd party software) use the following steps:

1. Connect the UHD-PRO3 to a PC using a DB9 (Stripped and connected to 3pin captive screw) to USB cable
2. Go to the Device Manager folder (see picture A)
3. Find the UHD-PRO3 COM port and right click with a mouse and select properties (see picture B)

NOTE: If unsure which COM port is the UHD-PRO3, unplug the cable and plug it back in. It will disappear and reappear on the COM port list.

4. Under the properties menu select the port settings tab and update the menu to the **UHD-PRO3 default settings of:** Bits Per Second: 115200, Data Bits: 8, Parity: None, Stop Bits: 1 and Flow Control: None. (see picture C)

Set up is done and any hyperterminal program may be used to control the UHD-PRO3 now.

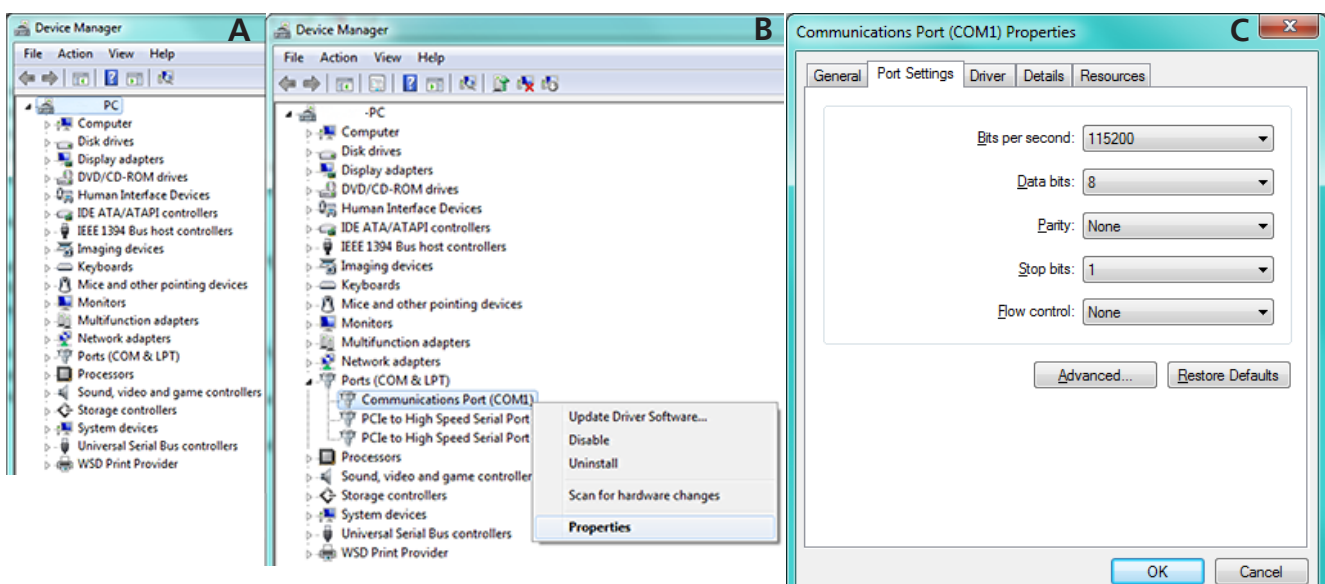

RS-232 & TCP/IP Control Commands

The command codes are case sensitive, do not change capitalization, spacing, or lettering.

Command	Feedback	Description
PWON	PWON	Power on
PWOFF	PWOFF	Power off
PWSTA	PWx	Will display the power status of the matrix Ex. Power is on, feedback will be PWON
Version	Firmware #	Brings up the current firmware version
Type	Model #	Brings up the model information
Lock	Lock	Locks the front panel of the matrix so no buttons are active
Unlock	Unlock	Unlocks the front panel of the matrix, enabling the buttons again
All#	x1AVx1,x2AVx2,...	Resets all inputs to corresponding outputs Ex. input 1 to output 1, input 2 to output 2, input 3 to output 3, etc
x1\$	x1\$	Turns off output channel Ex. to turn off output 3 = x3\$
x1All	x1All	Sets selected input to all outputs Ex. x3All would set input 3 to all
x1AVx2 Ex. x3AVx7	x1AVx2 Ex. x3AVx7	Switch input to output Ex. input 3 to output 7
x1AVx2,x3,x4 Ex. x3AVx1,x4	x1AVx2,x3,x4 Ex. x3AVx1,x4	Switch input to multiple outputs Ex. Switch input 3 to output 1 and 4
MirrorHdmiX OutY	MirrorHdmiX OutY	Mirror the HDMI output port with an HDBaseT output port Ex. Mirror HDMI 6 with Output 1: MirrorHdmi6 Out1
UnMirrorX Ex. UnMirror6	UnMirrorX Ex. UnMirror6	Removes the chosen HDMI port from mirror mode Ex. Unmirror HDMI 6 and no longer follows an HDBaseT output
VOUTX + Ex. VOUT2 +	VOUTX (YY) Ex. VOUT2 (-70)	Turns the volume of the chosen output (X) up one step Ex. Turn the volume up from level -71dB to -70dB on analog output 2
VOUTX - Ex. VOUT3 -	VOUTX (YY) Ex. VOUT3 (12)	Turns the volume of the chosen output (X) down one step Ex. Turn the volume down from level 13dB to 12dB on analog output 3
VOUTX (YY) Ex. VOUT1 (-50)	VOUTX (YY) Ex. VOUT1 (-50)	Set the volume of the chosen output (X) to a specific (YY) level Ex. Set the volume to -50dB on output 1
VOUTX sta	VOUTX (YY)	Displays the current volume level of the chosen output (X)
VOUTMuteX Y Ex. VOUTMute2 on	VOUTMuteX Y Ex. VOUTMute2 on	Mute the volume level of the chosen analog output Y=on,off,sta Ex. Mute the volume of analog output 2
IROFF	IROFF	Disables the front panel IR receiver window
IRON	IRON	Enables the front panel IR receiver window
Statusx1	x7AVx1	Shows what input is connected to selected output
Status	x1AVx1,x2AVx2, x3AVx4, ...	Displays which inputs are currently connected to which outputs
SaveY Ex. Save2	SaveY Ex. Save2	Saves I/O route settings for future use, preset options 0 to 8
RecallY Ex. Recall2	RecallY Ex. Recall2	Recalls saved I/O route settings for the chosen preset number
ClearY Ex. Clear2	ClearY Ex. Clear2	Erases the saved I/O route settings for the chosen preset number
Mreset	Mreset	Sets matrix back to the default settings
RS232zoneX[command] Ex. RS232zone1[PWRO]	RS232zoneX[command] Ex. RS232zone1[PWRO]	Send commands to devices connected to the receiver RS-232 ports. Commands are the same as the ones stated in this table. X = zone # Ex. Turning the power on for the device connected in zone 1

Each command or feedback is terminated with a carriage return.

Note: If the command fails or is incorrect the feedback should be "Command FAILED"

To help with zone troubleshooting the matrix will broadcast "#*PORTXX_[feedback]" when receiving any feedback from any zone.

Command	Feedback	Description
IPCFG	IP Addr : x.x.x.x Netmask : x.x.x.x Gateway : x.x.x.x IP Port: x.x.x	Displays IP address configuration
IPTimeout XX Ex. IPTimout120	IPTimeout XX Ex. IPTimout120	Determines amount of seconds of inactivity before TCP/IP disconnects
IPQuit	IPQuit	Logs out of TCP/IP
IPAddUser	TCP/IP username & password list: - user password - user password - user password	Will display a list of users
IPAddUser X Y	TCP/IP user was added	Add a user for TCP/IP control. X=User Y=Password Ex. IPAddUser Atlona 1234 (User=Atlona 1234=Password)
IPDelUser X	TCP/IP user was deleted	Delete a user from TCP/IP X=User (Ex. IPDelUser Atlona)
IPDHCP sta	IPDHCP sta Ex. IPDHCP on	Displays the status of DHCP
IPDHCP on	IPDHCP on	Turns DHCP on
IPDHCP off	IPDHCP off	Turns DHCP off
IPStatic X Y Z	IPStatic address netmask gateway	Sets a static IP address Ex. IPStatic 192.168.1.1 255.255.255.0 192.168.1.200
IPPort	IPPort Y	Set the TCP/IP port (ex. IPPort 230)
IPLogin sta	IPLogin sta Ex. IPLogin on	Displays IPLogin status Ex. IPLogin is on
IPLogin on	IPLogin on	Enables IPLogin
IPLogin off	IPLogin off	Disables IPLogin
Broadcast sta	Broadcast sta	Displays broadcast mode status
Broadcast on	Broadcast on	Enables broadcast mode
Broadcast off	Broadcast off	Disables broadcast mode

Remote Control

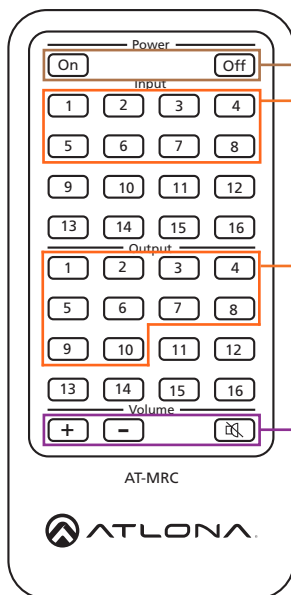

Turn the Matrix on or off (standby).

Input selection. Numbers correspond with the HDMI inputs (1-8) on the matrix.

Output selection. Numbers correspond with the outputs (1-10) on the matrix.

Volume control. Adjust analog audio output volume up and down or mute.

Note: Do not use any other battery than what is provided by Atlona. If the battery does not work, please contact Atlona for a replacement.

Captive Screw

Captive screw connectors are an added feature on the UHD-PRO3 matrix. The captive screw connectors allow you to cut cables down to a suitable length, reducing cable clutter while providing a more reliable connection.

Connecting

When connecting the cables to the female captive screw connector it is important that the wires be terminated correctly. The female captive screw connector has a contact plate at the top and must have the wires touching it for signal to pass. When wired correctly (see picture A) the signal will pass, incorrectly (see picture B) no signal will pass.

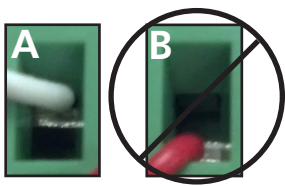

The captive screw connectors have a contact bar that is adjusted to compress the wire against the top contact plate. Use the screws at the top of the connector to compress the wire against the contact plate.



Clockwise
Turn the screws clockwise to raise the contact bar to the upper contact plate and hold the wires in place.



Counter Clockwise
Turn the screws counter clockwise to lower the contact bar to release the wires.

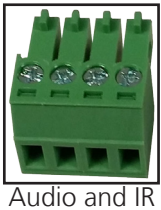

Two types of female captive screw connectors have been included: 4 pin (IR and Audio) and 5 pin (RS-232/IR).

The wires of the emitter is marked to differentiate pin outs.

Note: To view pin outs of audio and RS-232, see pages 7 and 21.

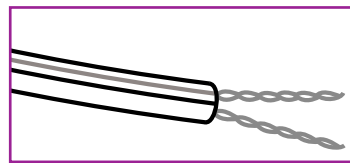
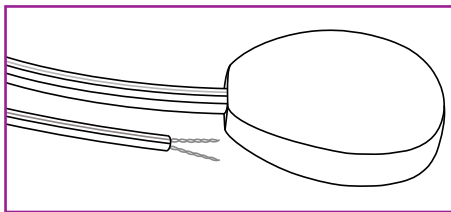

Signal (S)
Ground (⊕)

The IR emitter (AT-IR-CS-TX sold separately) has two wires: signal and ground. Signal will have a solid line and ground will be blank. The IR emitter will plug into the IR OUT ports.

Note: One AT-IR-CS-TX is included with the AT-UHD-EX-70C-RX (receiver) and AT-UHD-EX-100CE-RX (receiver).

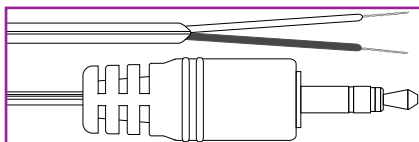

Signal (S)
Ground (⊕)

There are two wires on the IR captive screw ready cable (AT-LC-CS-IR-2M sold separately): signal and ground. The signal wire is red and ground wire is black. The IR cable will plug into the IR IN ports and connect to third party control systems.

Specifications

Video Resolutions

Video	4096x2160@24/25/30/50*/60Hz*, 3840x2160@24/25/30/50*/60Hz* (UHD), 2048x1080p, 1080p@23.98/24/25/29.97/30/50/59.94/60Hz, 1080i@50/59.94/60Hz, 720p@50/59.94/60Hz, 576p, 576i, 480p, 480i
VESA	2560x2048, 2560x1600, 2048x1536, 1920x1200, 1680x1050, 1600x1200, 1600x900, 1440x900, 1400x1050, 1366x768, 1360x768, 1280x1024, 1280x800, 1280x768, 1152x768, 1024x768, 800x600, 640x480
Colorspace	YUV, RGB
Chroma Subsampling	4:4:4, 4:2:2, 4:2:0*
Color depth	8-bit, 10-bit, 12-bit

Audio

Analog Out	PCM 2Ch (de-embedded)
HDMI/HDBaseT Out	PCM 2Ch, LPCM 5.1, LPCM 7.1, Dolby Digital, DTS 5.1, Dolby Digital Plus, Dolby TrueHD, DTS-HD Master Audio, Dolby Atmos
Sample Rate	32kHz, 44.1kHz, 48kHz, 88.2kHz, 96kHz, 176.4kHz, 192kHz
Bit rate	up to 24-bit

Distance

Ports 1-4:

CAT5e/6 @ 4K	up to 70M	up to 230 ft
CAT6a/7 @ 4K	up to 100M	up to 328 ft
CAT5e/6 @ 1080p	up to 100M	up to 328 ft

Ports 5-7,9:

CAT5e/6 @ 4K	up to 35 meters	up to 115 feet
CAT6a/7 @ 4K	up to 40 meters	up to 130 feet
CAT5e/6 @ 1080p	up to 60 meters	up to 197 feet
CAT6a/7 @ 1080p	up to 70 meters	up to 230 feet

HDMI IN/OUT

4K	up to 5 meters	up to 15 feet
1080p	up to 10 meters	up to 30 feet

Signal Support

Bandwidth	10.2 Gbps
CEC	No
HDCP	2.2

Temperature

Operating	0°C to 40°C	32°F to 104°F
Storage	-40°C to 70°C	-40°F to 158°F
Ambient	0°C to 70°C	32°F to 158°F
Humidity	20 to 90% non-condensing	

Power

Consumption	110W
Idle Consumption	75W
Supply	AC 100~240V 50/60Hz

Dimension

H x W x D w/feet	99.02 x 439.74 x 301.63 (mm)	3.90 x 17.31 x 11.88 (inch)
H x W x D w/rack ears	88.63 x 482.60 x 301.63 (mm)	3.49 x 19.00 x 11.88 (inch)
Rack Unit	2U	

Weight

Device	5.18 kg	11.4 lbs
--------	---------	----------

Certification

Product	CE, FCC, RoHS, RCM, TUV
---------	-------------------------

*4096x2160@50/60Hz & 3840x2160@50/60Hz supported @ chroma subsampling 4:2:0 8-bit only

Safety Information

Safeguards



To reduce the risk of electric shock, do not expose this product to rain or moisture



Do not modify the wall plug. Doing so will void the warranty and safety features.



If the wall plug does not fit into your local power socket, hire an electrician to replace your obsolete socket.



This equipment should be installed near a grounded socket outlet and the device should be easily accessible in the case it requires disconnection.

Precautions

FCC regulations state that any unauthorized changes or modifications to this equipment, not expressly approved by the manufacturer, could void the user's authority to operate this equipment.

In the event of an electrostatic discharge this device may automatically turn off. If this occurs, unplug the device and plug it back in.

Protect and route power cords so they will not be stepped on or pinched by anything placed on or against them. Be especially careful of plug-ins or cord exit points from this product.

Avoid excessive humidity, sudden temperature changes or temperature extremes.

Keep this product away from wet locations such as bathtubs, sinks, laundries, wet basements, fish tanks, and swimming pools.

Use only accessories recommended by Atlona to avoid fire, shock, or other hazards.

Unplug the product before cleaning. Use a damp cloth for cleaning and not cleaning fluid or aerosols. Such products could enter the unit and cause damage, fire, or electric shock. Some substances may also mar the finish of the product.

Never open, remove unit panels, or make any adjustments not described in this manual. Attempting to do so could expose you to dangerous electrical shock or other hazards. It may also cause damage to your product. Opening the product will void the warranty.

Do not attempt to service the unit. Disconnect the product and contact your authorized Atlona reseller or contact Atlona directly.

Atlona, Inc. ("Atlona") Limited Product Warranty Policy

Coverage

Atlona warrants its products will substantially perform to their published specifications and will be free from defects in materials and workmanship under normal use, conditions and service.

Under its Limited Product Warranty, Atlona, at its sole discretion, will either:

- A) repair or facilitate the repair of defective products within a reasonable period of time, restore products to their proper operating condition and return defective products free of any charge for necessary parts, labor and shipping
- OR**
- B) replace and return, free of charge, any defective products with direct replacement or with similar products deemed by Atlona to perform substantially the same function as the original products
- OR**
- C) refund the pro-rated value based on the remaining term of the warranty period, not to exceed MSRP, in cases where products are beyond repair and/or no direct or substantially similar replacement products exist.

Repair, replacement or refund of Atlona's products is the purchaser's exclusive remedy and Atlona's liability does not extend to any other damages, incidental, consequential or otherwise.

This Limited Product Warranty extends to the original end-user purchaser of Atlona's products and is non-transferrable to any subsequent purchaser(s) or owner(s) of these products.

Coverage Periods

Atlona's Limited Product Warranty Period begins on the date of purchase by the end-purchaser. The date contained on the end-purchaser's sales or delivery receipt is the proof purchase date.

Limited Product Warranty Terms – New Products

- 10 years from proof of purchase date for hardware/electronics products purchased on or after June 1, 2013
- 3 years from proof of purchase date for hardware/electronics products purchased before June 1, 2013
- Lifetime Limited Product Warranty for all cable products

Limited Product Warranty Terms – Refurbished (B-Stock) Products

- 3 years from proof of purchase date for all Refurbished (B-Stock) hardware and electronic products purchased on or after June 1, 2013

Remedy

Atlona recommends that end-purchasers contact their authorized Atlona dealer or reseller from whom they purchased their products. Atlona can also be contacted directly. Visit www.atlona.com for Atlona's contact information and hours of operation. Atlona requires that a dated sales or delivery receipt from an authorized dealer, reseller or end-purchaser is provided before Atlona extends its warranty services. Additionally, a return merchandise authorization (RMA) and/or case number, is required to be obtained from Atlona in advance of returns.

Atlona requires that products returned are properly packed, preferably in the original carton, for shipping. Cartons not bearing a return authorization or case number will be refused. Atlona, at its sole discretion, reserves the right to reject any products received without advanced authorization. Authorizations can be requested by calling 1-877-536-3976 (US toll free) or 1-408-962-0515 (US/international) or via Atlona's website at www.atlona.com.

Exclusions

This Limited Product Warranty excludes:

- Damage, deterioration or malfunction caused by any alteration, modification, improper use, neglect, improper packing or shipping (such claims must be presented to the carrier), lightning, power surges, or other acts of nature.
- Damage, deterioration or malfunction resulting from the installation or removal of this product from any installation, any unauthorized tampering with this product, any repairs attempted by anyone unauthorized by Atlona to make such repairs, or any other cause which does not relate directly to a defect in materials and/or workmanship of this product.
- Equipment enclosures, cables, power supplies, batteries, LCD displays, and any accessories used in conjunction with the product(s).
- Products purchased from unauthorized distributors, dealers, resellers, auction websites and similar unauthorized channels of distribution.

Disclaimers

This Limited Product Warranty does not imply that the electronic components contained within Atlona's products will not become obsolete nor does it imply Atlona products or their electronic components will remain compatible with any other current product, technology or any future products or technologies in which Atlona's products may be used in conjunction with. Atlona, at its sole discretion, reserves the right not to extend its warranty offering in instances arising outside its normal course of business including, but not limited to, damage inflicted to its products from acts of god.

Limitation on Liability

The maximum liability of Atlona under this limited product warranty shall not exceed the original Atlona MSRP for its products. To the maximum extent permitted by law, Atlona is not responsible for the direct, special, incidental or consequential damages resulting from any breach of warranty or condition, or under any other legal theory. Some countries, districts or states do not allow the exclusion or limitation of relief, special, incidental, consequential or indirect damages, or the limitation of liability to specified amounts, so the above limitations or exclusions may not apply to you.

Exclusive Remedy

To the maximum extent permitted by law, this limited product warranty and the remedies set forth above are exclusive and in lieu of all other warranties, remedies and conditions, whether oral or written, express or implied. To the maximum extent permitted by law, Atlona specifically disclaims all implied warranties, including, without limitation, warranties of merchantability and fitness for a particular purpose. If Atlona cannot lawfully disclaim or exclude implied warranties under applicable law, then all implied warranties covering its products including warranties of merchantability and fitness for a particular purpose, shall provide to its products under applicable law. If any product to which this limited warranty applies is a "Consumer Product" under the Magnuson-Moss Warranty Act (15 U.S.C.A. §2301, ET SEQ.) or other applicable law, the foregoing disclaimer of implied warranties shall not apply, and all implied warranties on its products, including warranties of merchantability and fitness for the particular purpose, shall apply as provided under applicable law.

Other Conditions

Atlona's Limited Product Warranty offering gives legal rights, and other rights may apply and vary from country to country or state to state. This limited warranty is void if (i) the label bearing the serial number of products have been removed or defaced, (ii) products are not purchased from an authorized Atlona dealer or reseller. A comprehensive list of Atlona's authorized distributors, dealers and resellers can be found at www.atlona.com.

Atlona, Inc Product Registration

Thank you for purchasing this Atlona product. - We hope you enjoy it and will take an extra few moments to register your new purchase.

Registration creates an ownership record if your product is lost or stolen and helps ensure you'll receive notification of performance issues and firmware updates.

At Atlona we respect and protect your privacy, assuring you that your registration information is completely secure. Atlona product registration is completely voluntary and failure to register will not diminish your limited warranty rights.

To register go to: <http://www.atlona.com/registration>