

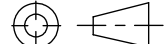

FOR MISSING DIMENSIONS AND FEATURE LOCATIONS REFER TO 3D CAD MODEL

NOTE: UNLESS OTHERWISE SPECIFIED

MATERIAL		The information herein is the property of SunBriteTV. No portion of this data shall be released, disclosed, used, or duplicated for any purposes without the written consent of SunBriteTV.		 2630 Townsgate Rd. Suite F. Westlake Village, CA 91361	
FINISH	NOTE 3	APPROVALS	DATE	TITLE	
FRACTIONS	DECIMALS	DESIGN	9/17/2021	SB 75V3 Top Assembly Ortho	
±.030	.X ± .05	DRAWN		SIZE	SCALE
.XX ± .03	.XXX ± .010	CM		B	1:10
UNLESS OTHERWISE SPECIFIED DIMENSIONS ARE IN INCHES		CHECKED		PART #	REV
THIRD ANGLE PROJECTION				210506210	1.0
		SHEET 1 OF 5			

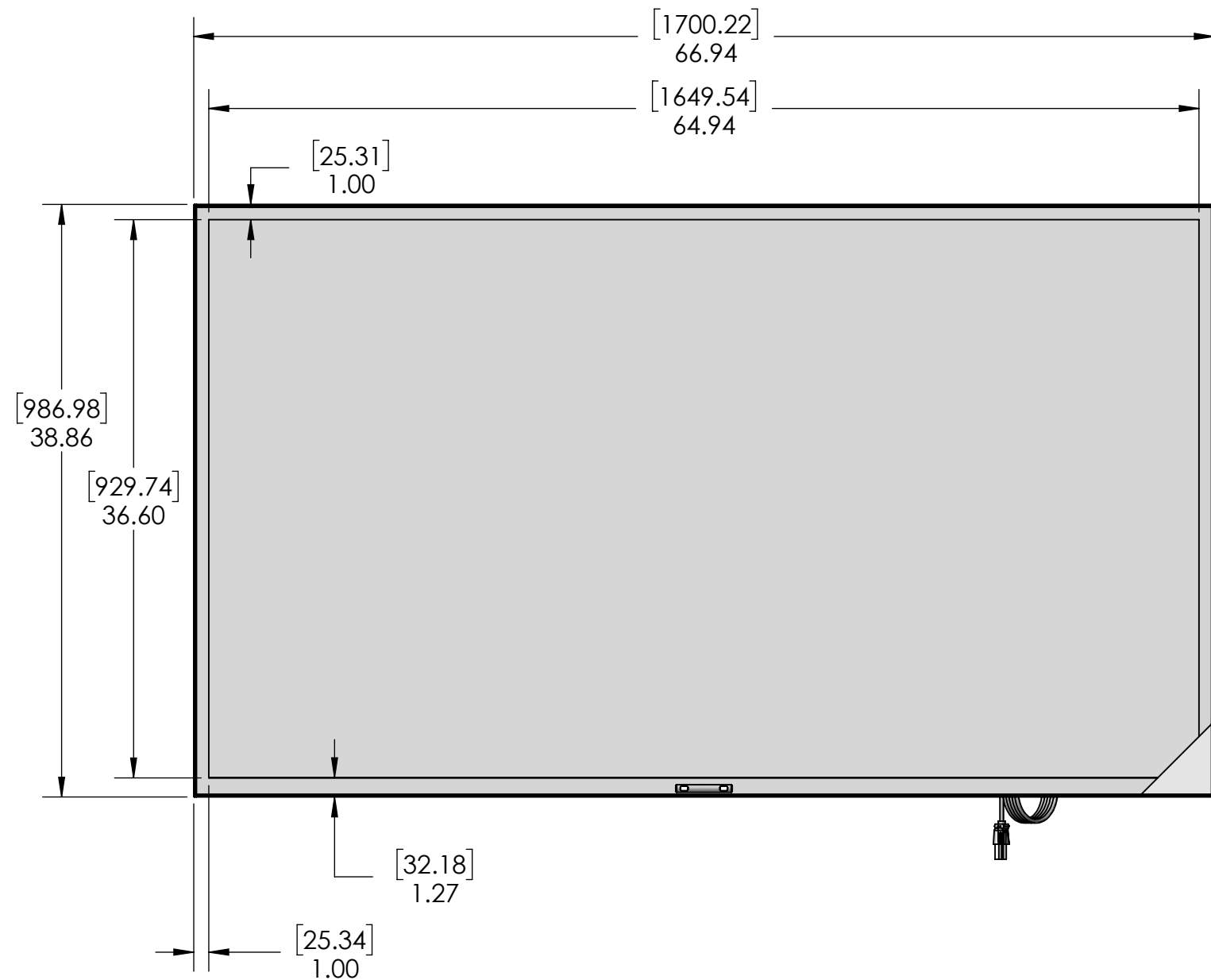

FOR MISSING DIMENSIONS AND FEATURE LOCATIONS REFER TO 3D CAD MODEL

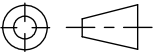
MATERIAL		The information herein is the property of SunBriteTV. No portion of this data shall be released, disclosed, used, or duplicated for any purposes without the written consent of SunBriteTV.		 2630 Townsgate Rd. Suite F. Westlake Village, CA 91361	
FINISH	NOTE 3	APPROVALS	DATE	TITLE	
FRACTIONS ±.030	DECIMALS .X ± .05 .XX ± .03 .XXX ± .010	DESIGN CM	9/17/2021	SB 75V3 Top Assembly Ortho	
UNLESS OTHERWISE SPECIFIED DIMENSIONS ARE IN INCHES		DRAWN CM		SIZE B	SCALE 1:10
THIRD ANGLE PROJECTION		CHECKED		PART # 210506210	REV 1.0
				SHEET 2 OF 5	

NOTE: UNLESS OTHERWISE SPECIFIED

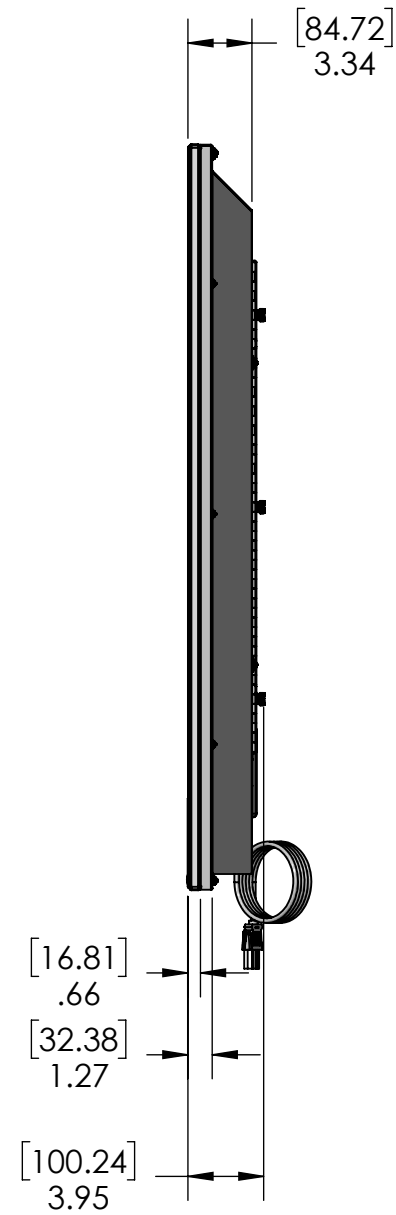

FOR MISSING DIMENSIONS AND FEATURE LOCATIONS REFER TO 3D CAD MODEL

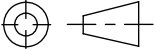
MATERIAL		The information herein is the property of SunBriteTV. No portion of this data shall be released, disclosed, used, or duplicated for any purposes without the written consent of SunBriteTV.		 2630 Townsgate Rd. Suite F. Westlake Village, CA 91361		
FINISH	NOTE 3	FRACTIONS DECIMALS ANGLES ±.030 .X ± .05 ± 1° .XX ± .03 .XXX ± .010		APPROVALS	DATE	TITLE
UNLESS OTHERWISE SPECIFIED DIMENSIONS ARE IN INCHES		DESIGN	CM	9/17/2021	SB 75V3 Top Assembly Ortho	
THIRD ANGLE PROJECTION		DRAWN	CM		SIZE B	SCALE 1:10
		CHECKED			PART # 210506210	REV 1.0
					SHEET 3 OF 5	

NOTE: UNLESS OTHERWISE SPECIFIED

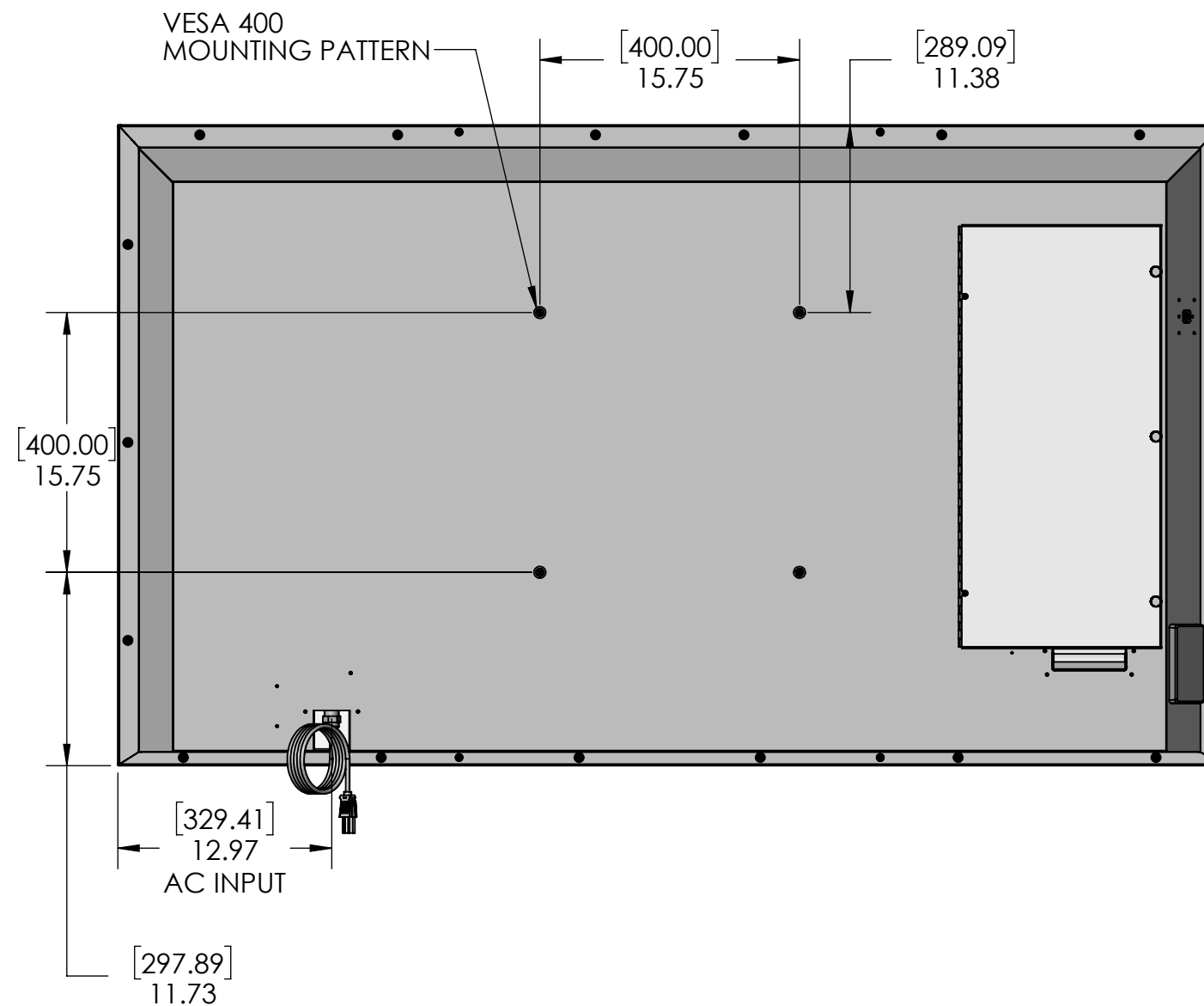

FOR MISSING DIMENSIONS AND FEATURE LOCATIONS REFER TO 3D CAD MODEL

NOTE: UNLESS OTHERWISE SPECIFIED

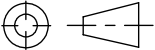
MATERIAL		The information herein is the property of SunBriteTV. No portion of this data shall be released, disclosed, used, or duplicated for any purposes without the written consent of SunBriteTV.		 2630 Townsgate Rd. Suite F. Westlake Village, CA 91361	
FINISH	NOTE 3	APPROVALS	DATE	TITLE	
FRACTIONS ±.030	DECIMALS .X ± .05 .XX ± .03 .XXX ± .010	DESIGN CM	9/17/2021	SB 75V3 Top Assembly Ortho	
UNLESS OTHERWISE SPECIFIED DIMENSIONS ARE IN INCHES		DRAWN CM		SIZE B	SCALE 1:10
THIRD ANGLE PROJECTION		CHECKED		PART #	REV
				210506210	1.0
		SHEET 4 OF 5			

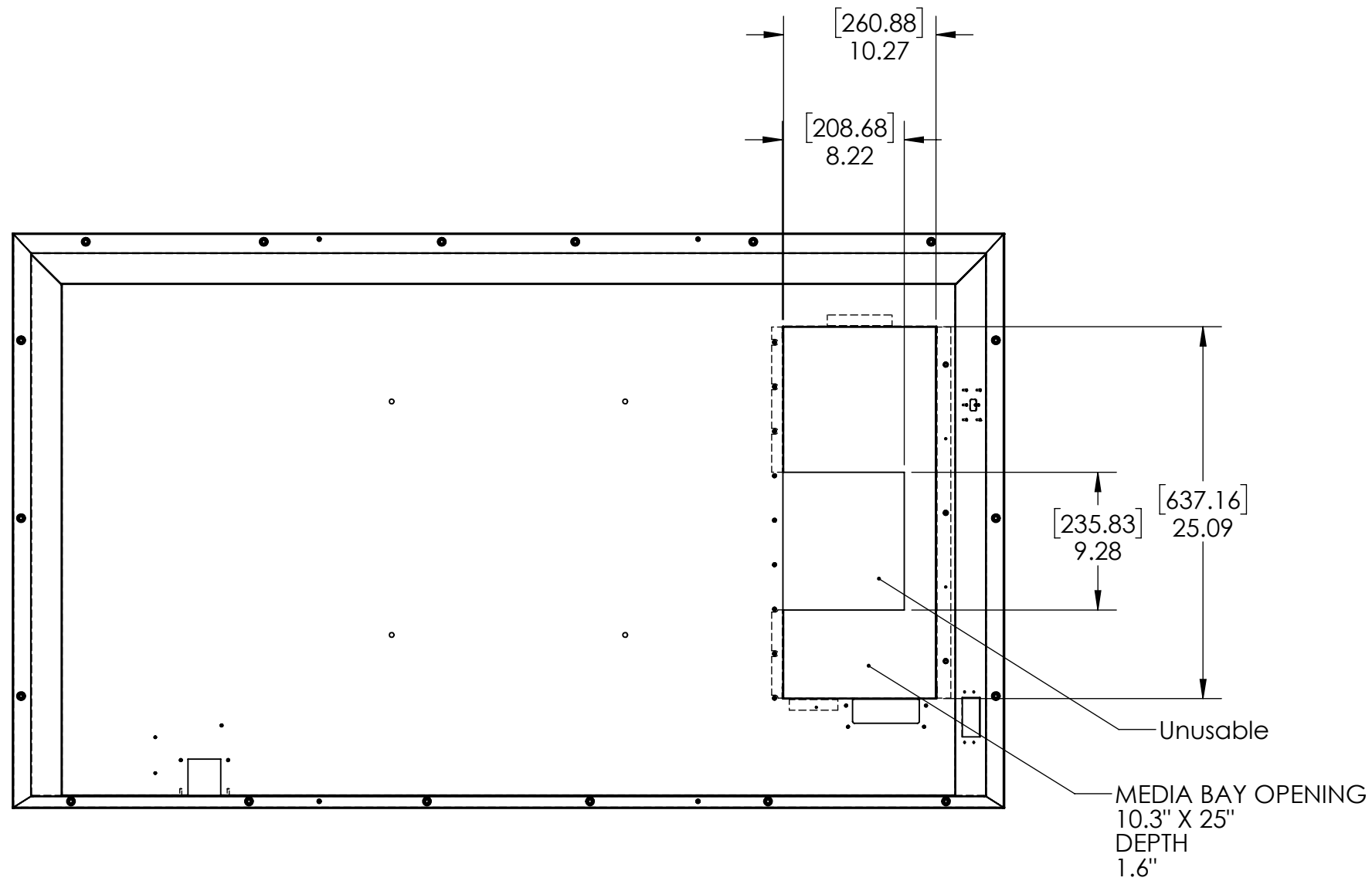

FOR MISSING DIMENSIONS AND FEATURE LOCATIONS REFER TO 3D CAD MODEL

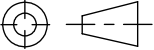
MATERIAL		The information herein is the property of SunBriteTV. No portion of this data shall be released, disclosed, used, or duplicated for any purposes without the written consent of SunBriteTV.		 2630 Townsgate Rd. Suite F. Westlake Village, CA 91361	
FINISH	NOTE 3	APPROVALS	DATE	TITLE	
FRACTIONS ±.030	DECIMALS .X ± .05 .XX ± .03 .XXX ± .010	DESIGN CM	9/17/2021	SB 75V3 Top Assembly Ortho	
UNLESS OTHERWISE SPECIFIED DIMENSIONS ARE IN INCHES		DRAWN CM		SIZE B	SCALE 1:10
THIRD ANGLE PROJECTION		CHECKED		PART # 210506210	REV 1.0
				SHEET 5 OF 5	

NOTE: UNLESS OTHERWISE SPECIFIED