

## D-ILA PROJECTOR

# DLA-RS3000 DLA-RS2000 DLA-RS1000

**D-ILA**<sup>®</sup>  
**HDMI**<sup>™</sup>  
HIGH-DEFINITION MULTIMEDIA INTERFACE

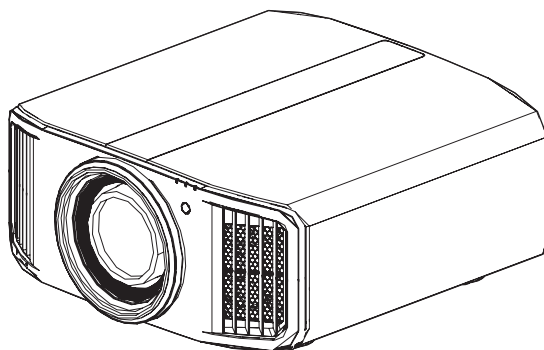

Mobile User Guide

● <http://manual3.jvckenwood.com/projector/mobile/global/>

The Mobile User Guide can be viewed on mobile internet devices including smartphones and tablets.



### For Customer use :

Enter below the serial No. which is located on the side of the cabinet. Retain this information for future reference.

DLA-RS3000 K,  
DLA-RS2000 K,  
Model No. DLA-RS1000 K,  
Serial No. \_\_\_\_\_

### Pour utilisation par le client :

Entrerci-dessous le N° de série qui est situé sous le boîtier. Garder cette information comme référence pour le futur.

DLA-RS3000 K,  
DLA-RS2000 K,  
N° de modèle DLA-RS1000 K,  
N° de série \_\_\_\_\_

### Instrucción para el cliente :

Introduzca a continuación el n° de serie que aparece en la parte inferior lateral de la caja. Conserve esta información como referencia para uso ulterior.

DLA-RS3000 K,  
DLA-RS2000 K,  
Modelo N° DLA-RS1000 K,  
N° de serie \_\_\_\_\_

Not suitable for household room illumination.

# Safety Precautions

## IMPORTANT INFORMATION

This product has a High Intensity Dis-charge (HID) lamp that contains mercury. Manage in accord with disposal laws.

Disposal of these materials may be regulated in your community due to environmental considerations. For disposal or recycling information, please contact your local authorities or for USA, the Electronic Industries Alliance: <http://www.eiae.org>. or call 1-800-252-5722(For USA) or 1-800-964-2650(For Canada).

### WARNING:

TO PREVENT FIRE OR SHOCK HAZARDS, DO NOT EXPOSE THIS APPLIANCE TO RAIN OR MOISTURE.

### WARNING:

THIS APPARATUS MUST BE EARTHED.

### CAUTION:

To reduce the risk of electric shock, do not remove cover. Refer servicing to qualified service personnel.

This projector is equipped with a 3-blade grounding type plug to satisfy FCC rule. If you are unable to insert the plug into the outlet, contact your electrician.

### NOISE EMISSION DECLARATION

The sound pressure level at the operator position is equal or less than 50dB(A) according to ISO7779.

### For the customers in Taiwan only



廢電池請回收

## FCC INFORMATION (U.S.A. only)

### CAUTION:

Changes or modification not approved by JVC could void the user's authority to operate the equipment.

### NOTE:

This equipment has been tested and found to comply with the limits for Class B digital devices, pursuant to Part 15 of the FCC Rules. These limits are designed to provide reasonable protection against harmful interference in a residential installation. This equipment generates, uses, and can radiate radio frequency energy and, if not installed and used in accordance with the instructions, may cause harmful interference to radio communications. However, there is no guarantee that interference will not occur in a particular installation. If this equipment does cause harmful interference to radio or television reception, which can be determined by turning the equipment off and on, the user is encourage to try to correct the interference by one or more of the following measures:

- Reorient or relocate the receiving antenna.
- Increase the separation between the equipment and receiver.
- Connect the equipment into an outlet on a circuit different from that to which the receiver is connected.
- Consult the dealer or an experienced radio/TV technician for help.

### Declaration of Conformity

Model Number: DLA-RS3000K, DLA-RS2000K, DLA-RS1000K

Trade Name: JVC

Responsible party: JVCKENWOOD USA Corporation

Address: 500 Valley Road, Suite 203 Wayne, NJ 07470

Telephone Number: 973-317-5000

This device complies with Part 15 of FCC Rules.

Operation is subject to the following two conditions:

- (1) This device may not cause harmful interference, and
- (2) this device must accept any interference received, including interference that may cause undesired operation.

### About the installation place

Do not install the projector in a place that cannot support its weight securely.

If the installation place is not sturdy enough, the projector could fall or overturn, possibly causing personal injury.

## IMPORTANT SAFEGUARDS

Electrical energy can perform many useful functions. This unit has been engineered and manufactured to assure your personal safety. But **IMPROPER USE CAN RESULT IN POTENTIAL ELECTRICAL SHOCK OR FIRE HAZARD.** In order not to defeat the safeguards incorporated into this product, observe the following basic rules for its installation, use and service. Please read these Important Safeguards carefully before use.

- All the safety and operating instructions should be read before the product is operated.
- The safety and operating instructions should be retained for future reference.
- All warnings on the product and in the operating instructions should be adhered to.
- All operating instructions should be followed.
- Place the projector near a wall outlet where the plug can be easily unplugged.
- Unplug this product from the wall outlet before cleaning.
- Do not use liquid cleaners or aerosol cleaners. Use a damp cloth for cleaning.
- Do not use attachments not recommended by the product manufacturer as they may be hazardous.
- Do not use this product near water. Do not use immediately after moving from a low temperature to high temperature, as this causes condensation, which may result in fire, electric shock, or other hazards.
- Do not place this product on an unstable cart, stand, or table. The product may fall, causing serious injury to a child or adult, and serious damage to the product. The product should be mounted according to the manufacturer's instructions, and should use a mount recommended by the manufacturer.
- When the product is used on a cart, care should be taken to avoid quick stops, excessive force, and uneven surfaces which may cause the product and cart to overturn, damaging equipment or causing possible injury to the operator.

PORTABLE CART WARNING  
(symbol provided by RETAC)



S3126A

- Slots and openings in the cabinet are provided for ventilation. These ensure reliable operation of the product and protect it from overheating. These openings must not be blocked or covered. (The openings should never be blocked by placing the product on bed, sofa, rug, or similar surface. It should not be placed in a built-in installation such as a bookcase or rack unless proper ventilation is provided and the manufacturer's instructions have been adhered to.)
- To allow better heat dissipation, keep a clearance between this unit and its surrounding as shown below. When this unit is enclosed in a space of dimensions as shown below, use an air-conditioner so that the internal and external temperatures are the same. Overheating can cause damage.

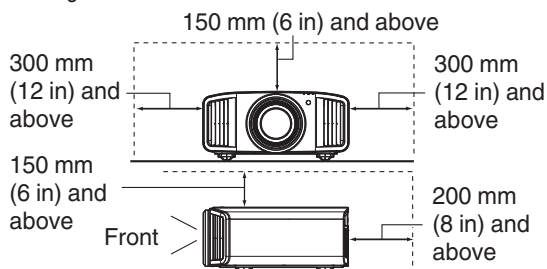

- Power source indicated on the label. If you are not sure of the type of power supply to your home, consult your product dealer or local power company.
- This product is equipped with a three-wire plug. This plug will fit only into a grounded power outlet. If you are unable to insert the plug into the outlet, contact your electrician to install the proper outlet. Do not defeat the safety purpose of the grounded plug.
- Power-supply cords should be routed so that they are not likely to be walked on or pinched by items placed upon or against them. Pay particular attention to cords at doors, plugs, receptacles, and the point where they exit from the product.
- For added protection of this product during a lightning storm, or when it is left unattended and unused for long periods of time, unplug it from the wall outlet and disconnect the cable system. This will prevent damage to the product due to lightning and power line surges.
- Do not overload wall outlets, extension cords, or convenience receptacles on other equipment as this can result in a risk of fire or electric shock.
- Never push objects of any kind into this product through openings as they may touch dangerous voltage points or short out parts that could result in a fire or electric shock. Never spill liquid of any kind on the product.
- Do not attempt to service this product yourself as opening or removing covers may expose you to dangerous voltages and other hazards. Refer all service to qualified service personnel.
- Unplug this product from the wall outlet and refer service to qualified service personnel under the following conditions:
  - a) When the power supply cord or plug is damaged.
  - b) If liquid has been spilled, or objects have fallen on the product.
  - c) If the product has been exposed to rain or water.
  - d) If the product does not operate normally by following the operating instructions. Adjust only those controls that are covered by the Operation Manual, as an improper adjustment of controls may result in damage and will often require extensive work by a qualified technician to restore the product to normal operation.
  - e) If the product has been dropped or damaged in any way.
  - f) When the product exhibits a distinct change in performance, this indicates a need for service.

- When replacement parts are required, be sure the service technician has used replacement parts specified by the manufacturer or with same characteristics as the original part. Unauthorized substitutions may result in fire, electric shock, or other hazards.
- Upon completion of any service or repairs to this product, ask the service technician to perform safety checks to determine that the product is in proper operating condition.
- The product should be placed more than one foot away from heat sources such as radiators, heat registers, stoves, and other products (including amplifiers) that produce heat.
- When connecting other products such as VCR's, and DVD players, you should turn off the power of this product for protection against electric shock.

- Do not place combustibles behind the cooling fan. For example, cloth, paper, matches, aerosol cans or gas lighters that present special hazards when over heated.
- Do not look into the projection lens while the illumination lamp is turned on. Exposure of your eyes to the strong light can result in impaired eyesight.
- Do not look into the inside of this unit through vents (ventilation holes), etc. Do not look at the illumination lamp directly by opening the cabinet while the illumination lamp is turned on. The illumination lamp also contains ultraviolet rays and the light is so powerful that your eyesight can be impaired.
- Do not drop, hit, or damage the light-source lamp (lamp unit) in any way. It may cause the light-source lamp to break and lead to injuries. Do not use a damaged light source lamp. If the light-source lamp is broken, ask your dealer to repair it. Fragments from a broken light-source lamp may cause injuries.
- The light-source lamp used in this projector is a high pressure mercury lamp. Be careful when disposing of the light-source lamp. If anything is unclear, please consult your dealer.
- Do not ceiling-mount the projector to a place which tends to vibrate; otherwise, the attaching fixture of the projector could be broken by the vibration, possibly causing it to fall or overturn, which could lead to personal injury.
- Use only the accessory cord designed for this product to prevent shock.
- For health reasons, please take a break of about 5-15 minutes every 30-60 minutes and let your eyes rest. Please refrain from watching any 3D-images when you feel tired, unwell or if you feel any other discomfort. Moreover, in case you see a double image, please adjust the equipment and software for proper display. Please stop using the unit if the double image is still visible after adjustment.
- Once every three years, please perform an internal test. This unit is provided with replacement parts needed to maintain its function (such as cooling fans). Estimated replacement time of parts can vary greatly depending on frequency of use and the respective environment. For replacement, please consult your dealer, or the nearest authorized JVC service center.
- When fixing the unit to the ceiling, Please note that we do not take any responsibility, even during the warranty period, if the product is damaged due to use of metal fixtures used for fixation to the ceiling other than our own or if the installation environment of said metal fixtures is not appropriate. If the unit is suspended from the ceiling during use, please be careful in regard to the ambient temperature of the unit. If you use a central heating, the temperature close to the ceiling will be higher than normally expected.
- Video images can burn into the electronic component parts. Please do not display screens with still images of high brightness or high contrast, such as found in video games and computer programs. Over a long period of time it might stick to the picture element. There is no problem with the playback of moving images, e.g. normal video footage.
- Not using the unit for a long time can lead to malfunction. Please power it on and let it run occasionally. Please avoid using the unit in a room where cigarettes are smoked. It is impossible to clean optical component parts if they are contaminated by nicotine or tar. This might lead to performance degradation.
- Please watch from a distance three times the height of the projected image size. Persons with photosensitivity, any kind of heart disease, or weak health should not use 3D glasses.
- Watching 3D-images might be cause of illness. If you feel any change in your physical condition, please stop watching immediately and consult a physician if necessary.
- When watching 3D images, it is recommended to take regular breaks. As the length and frequency of the required breaks differ for every person, please judge according to your own condition.
- If your child watches while wearing 3D glasses, it should be accompanied by its parents or an adult guardian. The adult guardian should be careful to avoid situations where the child's eyes might become tired, as responses to tiredness and discomfort, etc., are hard to detect, and it is possible for the physical condition to deteriorate very quickly. As the visual sense is not yet fully developed in children under the age of 6, please consult a physician in regard to any problem concerning 3D-images if necessary.
- Note that when using the 3D feature, the video output may appear different from the original video image due to image conversion on the device.

**\* DO NOT allow any unqualified person to install the unit.**

Be sure to ask your dealer to install the unit (e.g. attaching it to the ceiling) since special technical knowledge and skills are required for installation. If installation is performed by an unqualified person, it may cause personal injury or electrical shock.

- Do not use optical instruments (such as magnifying glass or reflector) viewing the laser output. It may pose an eye hazard.
- When turning on the projector, ensure that no one is looking into the projection lens.
- Do not look into the lens and openings when the light is on. Doing so would have serious effects on the human body.
- Do not detach or attach the projection lens with the power connected.
- Attempting to disassemble, repair or modify the projector yourself may lead to serious safety issues.
- Using a faulty product not only results in electrical shock or fire hazard, it can cause visual impairment.
- When abnormality occur, stop using the projector immediately and send it to your authorized dealer for repair.



## POWER CONNECTION

For USA and Canada only  
Use only the following power cord.

### Power cord



The power supply voltage rating of this product is AC100V – AC240V. Use only the power cord designated by our dealer to ensure Safety and EMC. Ensure that the power cable used for the projector is the correct type for the AC outlet in your country. Consult your product dealer.

### Power cord

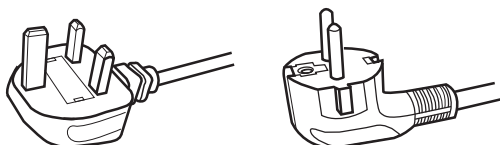

For United Kingdom

For European continent  
countries

### WARNING:

**Do not cut off the main plug from this equipment.**

If the plug fitted is not suitable for the power points in your home or the cable is too short to reach a power point, then obtain an appropriate safety approved extension lead or adapter or consult your dealer. If nonetheless the mains plug is cut off, dispose of the plug immediately, to avoid a possible shock hazard by inadvertent connection to the main supply.

### WARNING:

**THIS APPARATUS MUST BE EARTHED.**

### Dear Customer,

This apparatus is in conformance with the valid European directives and standards regarding electromagnetic compatibility and electrical safety.

European representative of  
JVC KENWOOD Corporation is:  
JVCKENWOOD Deutschland GmbH  
Konrad-Adenauer-Allee 1-11,  
61118 Bad Vilbel,  
GERMANY

### IMPORTANT (Europe only):

The wires in the mains lead on this product are colored in accordance with the following code:

Green-and-yellow	: Earth
Blue	: Neutral
Brown	: Live

As these colors may not correspond with the colored making identifying the terminals in your plug, proceed as follows:

The wire which is colored green-and-yellow must be connected to the terminal which is marked M with the letter E or the safety earth or colored green or green-and-yellow. The wire which is colored blue must be connected to the terminal which is marked with the letter N or colored black.

The wire which is colored brown must be connected to the terminal which is marked with the letter L or colored red.

## POWER CONNECTION (United Kingdom only)

### HOW TO REPLACE THE FUSE:

When replacing the fuse, be sure to use only a correctly rated approved type, re-fit the fuse cover.

### IF IN DOUBT — CONSULT A COMPETENT ELECTRICIAN.

Open the fuse compartment with the blade screwdriver, and replace the fuse.

(\* An example is shown in the illustration below.)

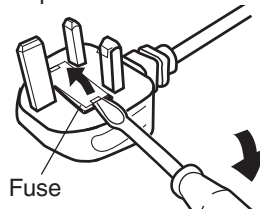

### Information for Users on Disposal of Old Equipment and Batteries



Products



Battery

#### [European Union only]

These symbols indicate that equipment with these symbols should not be disposed of as general household waste. If you want to dispose of the product or battery, please consider the collection systems or facilities for appropriate recycling.

**Notice:** The sign Pb below the symbol for batteries indicates that this battery contains lead.

### Informations relatives à l'élimination des appareils et des piles usagés, à l'intention des utilisateurs



Produits



Pile

#### [Union européenne seulement]

Si ces symboles figurent sur les produits, cela signifie qu'ils ne doivent pas être jetés comme déchets ménagers. Si vous voulez jeter ce produit ou cette pile, veuillez considérer le système de collecte des déchets ou les centres de recyclage appropriés.

**Notification:** La symbole Pb en dessous du symbole des piles indique que cette pile contient du plomb.

### Información para los usuarios sobre la eliminación de baterías/pilas usadas



Productos



Baterías/pilas

#### [Sólo Unión Europea]

Estos símbolos indican que el equipo con estos símbolos no debe desecharse con la basura doméstica. Si desea desechar el producto o batería/pila, acuda a los sistemas o centros de recogida para que los reciclen debidamente.

**Atención:** La indicación Pb debajo del símbolo de batería/pila indica que ésta contiene plomo.

### Benutzerinformationen zur Entsorgung alter Geräte und Batterien



Produkte



Batterie

#### [Nur Europäische Union]

Diese Symbole zeigen an, dass derartig gekennzeichnete Geräte nicht als normaler Haushaltsabfall entsorgt werden dürfen. Wenden Sie sich zur Entsorgung des Produkts oder der Batterie an die hierfür vorgesehenen Sammelstellen oder Einrichtungen, damit eine fachgerechte Wiederverwertung möglich ist.

**Hinweis:** Das Zeichen Pb unterhalb des Batteriesymbols gibt an, dass diese Batterie Blei enthält.

### Informazioni per gli utenti sullo smaltimento delle apparecchiature e batterie obsolete



Prodotti



Batteria

#### [Solo per l'Unione Europea]

Questi simboli indicano che le apparecchiature a cui sono relativi non devono essere smaltite tra i rifiuti domestici generici. Se si desidera smaltire questo prodotto o questa batteria, prendere in considerazione i sistemi o le strutture di raccolta appropriati per il riciclaggio corretto.

**Nota:** Il simbolo Pb sotto il simbolo delle batterie indica che questa batteria contiene piombo.

### Informatie voor gebruikers over het verwijderen van oude apparatuur en batterijen



Producten



Batterij

#### [Alleen Europese Unie]

Deze symbolen geven aan dat apparatuur met dit symbool niet mag worden weggegooid als algemeen huishoudelijk afval. Als u het product of de batterij wilt weggoien, kunt u inzamelsystemen of faciliteiten voor een geschikte recycling gebruiken.

**Opmerking:** Het teken Pb onder het batterijsymbool geeft aan dat deze batterij lood bevat.

IEC62471-5

Location information of the mark

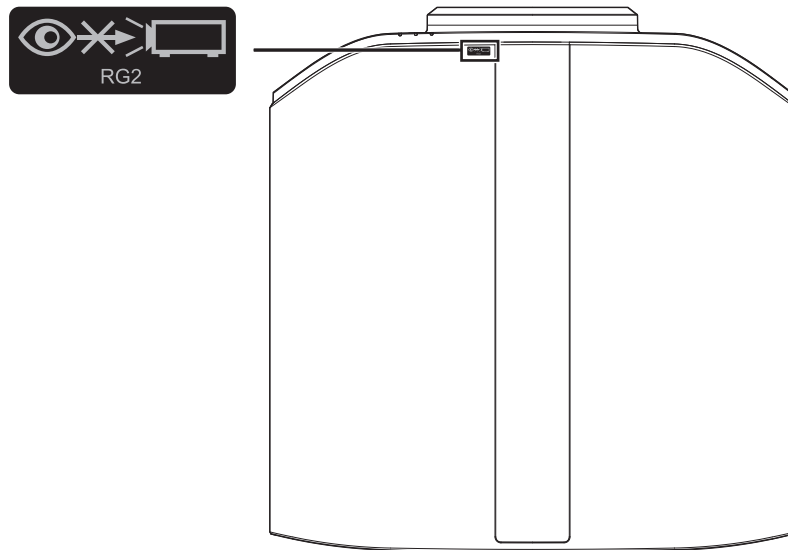

As with any bright light source, do not stare into the beam, RG2 IEC 62471-5:2015

# Contents

## Getting Started

Safety Precautions .....	2
Accessories/Optional Accessories .....	9
Check the Accessories .....	9
Optional Accessories .....	9
Controls and Features .....	10
Main Unit - Front .....	10
Main Unit - Bottom .....	10
Main Unit - Side .....	11
Main Unit - Rear .....	11
Main Unit - Input Terminals .....	12
Remote Control .....	13
Loading Batteries into the Remote Control .....	14
Effective Range of Remote Control Unit .....	14
Menu .....	15

## Set up







Installing the Projector .....	16
Precautions during Installation .....	16
Precautions during Mounting .....	17
Adjusting the Position .....	18
Connecting the Projector .....	19
Connecting to the HDMI Input Terminal (Digital Input) .....	19
Connecting to the LAN Terminal .....	20
Connecting to the RS-232C Terminal .....	20
Connecting to the TRIGGER Terminal .....	21
Connecting the Power Cord (Supplied Accessory) .....	21

## Operate

Viewing Videos .....	22
Adjusting the Projector Screen .....	24
Adjusting the Lens According to the Projection Position .....	24
Setting Screen Correction .....	25
Adjusting the Screen Size (Aspect) .....	26
Viewing 3D Movies .....	27
Installing the 3D Synchro Emitter .....	27
Viewing 3D Movies .....	28
Adjusting 3D Movies .....	28

## Adjust/Set

Selecting an Image Quality According to the Video Type .....	29
Setting the Picture Mode .....	29
Setting the Color Profile .....	30
Adjusting to your Preferred Color (Color Management) .....	31
Viewing HDR Contents .....	33
Original HDR Technology of JVC .....	33
Adjusting Movies for Increased Detail and Sharpness (Multiple Pixel Control) .....	35

Fine-tuning the Image Quality .....	36
Adjusting the Output Value of the Projected Image (Gamma) .....	36
Fine-tuning to the Preferred Gamma Setting .....	38
Set Auto Tone Mapping .....	40
Reducing the After-image of Fast-moving Images (Motion Control) .....	42
Adjustments and Settings in the Menu .....	44
List of Menu Items .....	44
 Picture Adjust .....	46
 Input Signal .....	51
 Installation .....	53
 Display Setup .....	60
 Function .....	61
 Information .....	63

## Maintenance

Replacing the Lamp .....	64
Lamp Replacement Procedure .....	64
Resetting the Lamp Time .....	66
Maintaining the Cabinet and Remote Control .....	67
Cleaning and Replacing the Filter .....	67

## Troubleshooting

Troubleshooting .....	68
When the Following Messages Appear... ..	72

## Others

External Control .....	73
RS-232C Specifications .....	73
TCP/IP Connection .....	73
Command Format .....	74
Remote Control Code .....	75
Communications Example .....	76
Specifications .....	77
Index .....	88

## Symbols used in this manual

 indicates a function that is supported by DLA-RS3000.

 indicates a function that is supported by DLA-RS2000.

 indicates a function that is supported by DLA-RS1000.

Items not marked with any of the above symbols are supported by all models.

The illustrations of the projector unit used in this manual are those of DLA-RS3000. The appearance of the projector of other models may differ slightly.

# Accessories/Optional Accessories

## Check the Accessories

Lens cover ..... 1 piece

\* It is attached to the main unit at the time of shipment.

Remote control ..... 1 piece

AAA-size batteries (for operational check) ..... 2 pieces

Power cord (for USA) (about. 2 m (about. 78.7 in)) ..... 1 piece

Power cord (for UK) (about. 2 m (about. 78.7 in)) ..... 1 piece

Power cord (for EU) (about. 2 m (about. 78.7 in)) ..... 1 piece

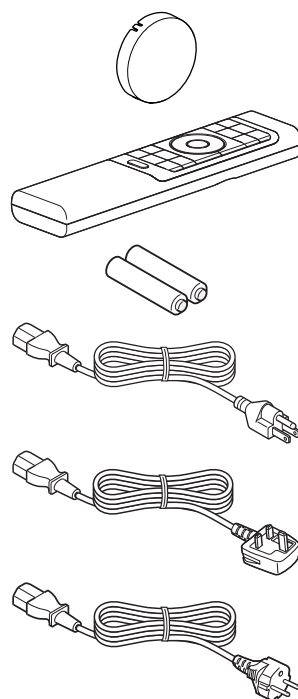

- Quick User Guide, safety precautions, warranty card, and other printed material are also included.
- Be sure to read the “Safety Precautions” before using this projector.
- For details on mounting the badge, refer to the instruction manual provided with the badge.

## Optional Accessories

- Replacement lamp: Product no. PK-L2618U
- 3D Glasses: model PK-AG3
- 3D Synchro Emitter: model PK-EM2

### Compatibility Chart for 3D Synchro Emitter and 3D Glasses

		3D Glasses		
		PK-AG1 (Communication Method: IR (Infrared))	PK-AG2 (Communication Method: IR (Infrared))	PK-AG3 (Communication Method: RF (Radio frequency))
3D Synchro Emitter	PK-EM1 (Communication Method: IR (Infrared))	○	○	—
	PK-EM2 (Communication Method: RF (Radio frequency))	—	—	○



# Controls and Features

## Main Unit - Front

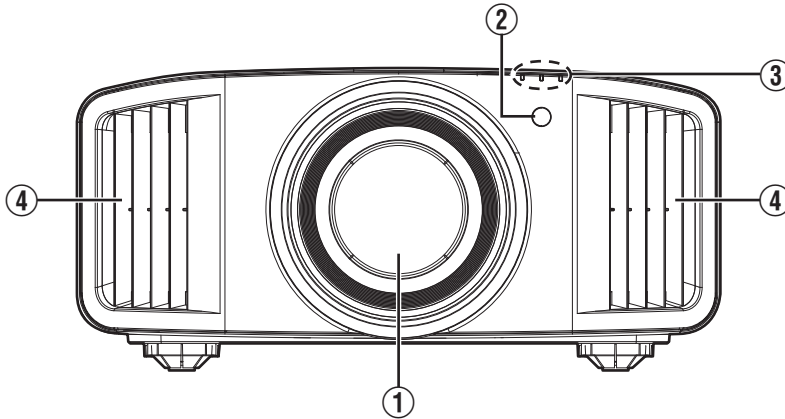

### ① Lens

This is a projection lens. Do not look through the lens while an image is projected.

### ② Remote Sensor (front)

Please aim the remote control at this area when using it.

\* There is also a remote sensor at the rear.

### ③ Indicator

Refer to "Indicator Display on the Main Unit" P. 84.

### ④ Exhaust vent

Warm air is discharged to cool down the internal temperature.  
Do not block the vents.

## Main Unit - Bottom

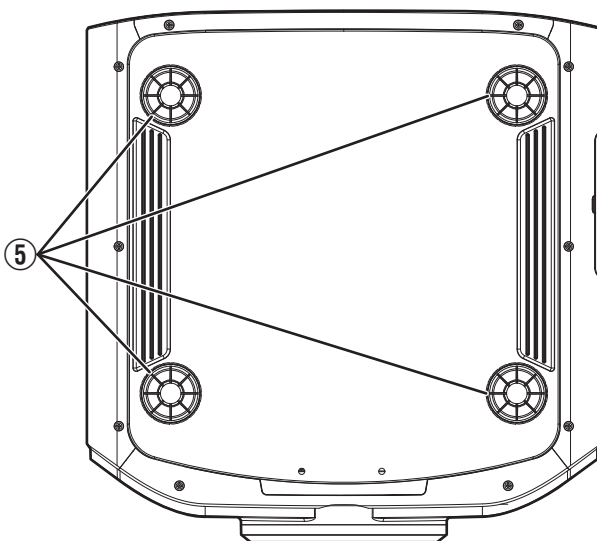

### ⑤ Feet

The height and angle of the projector can be adjusted by turning the foot. (0~5 mm (0~0.2 in)) (P. 18)

When the foot is removed, it can be used as the mounting hole for the ceiling mount bracket.

## Main Unit - Side

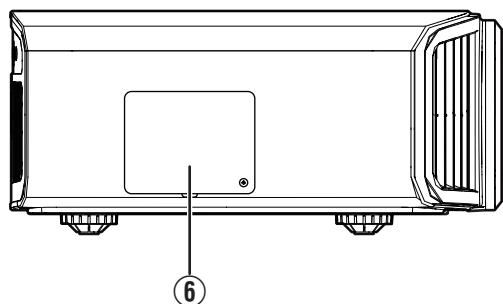

### ⑥ Lamp Cover

When replacing the light source lamp, remove this cover. (P. 64)

## Main Unit - Rear

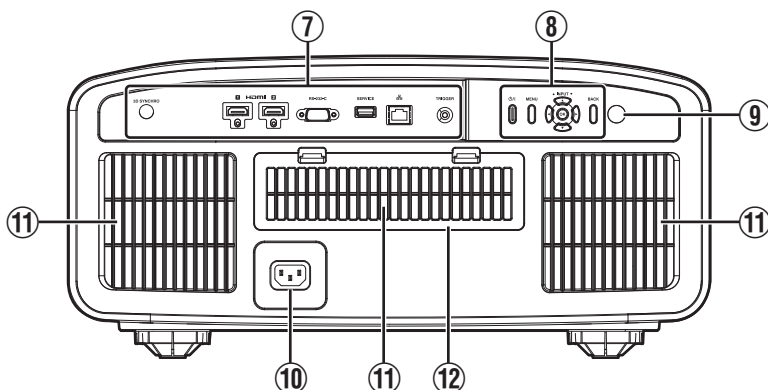

### ⑦ Input terminals

In addition to the video input terminal, there are also other connection terminals for devices such as controllers and optional equipment.

Please see “Main Unit - Input Terminals”P. 12 for more details about the terminals.

### ⑧ Operation panel

For more details, please refer to the “Operation panel” in the diagram below.

### ⑨ Remote Sensor (rear)

Please aim the remote control at this area when using it.

\* There is also a remote sensor at the front.

### ⑩ Power input terminal

Connect the supplied power cord to this terminal.

### ⑪ Air Inlets

The inlets take in air to cool down the internal temperature.

Do not block the inlet. Do not blow hot air on the inlet. Doing so may cause the unit to malfunction.

### ⑫ Filter Cover

To perform maintenance of the filter, remove this cover. (P. 67)

## Operation panel

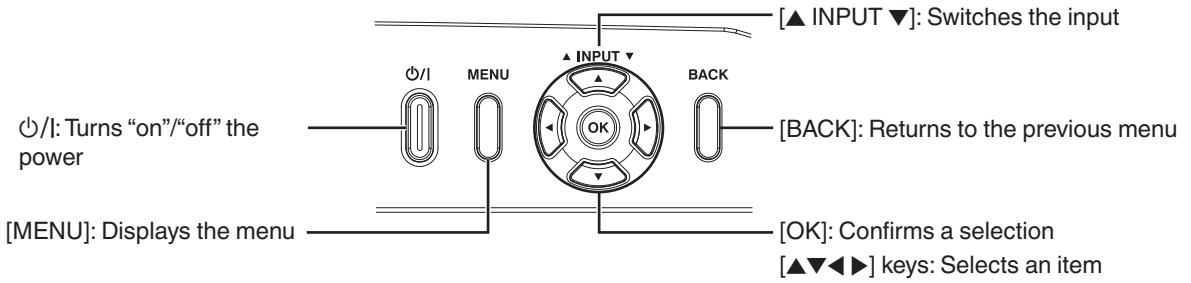

## Main Unit - Input Terminals

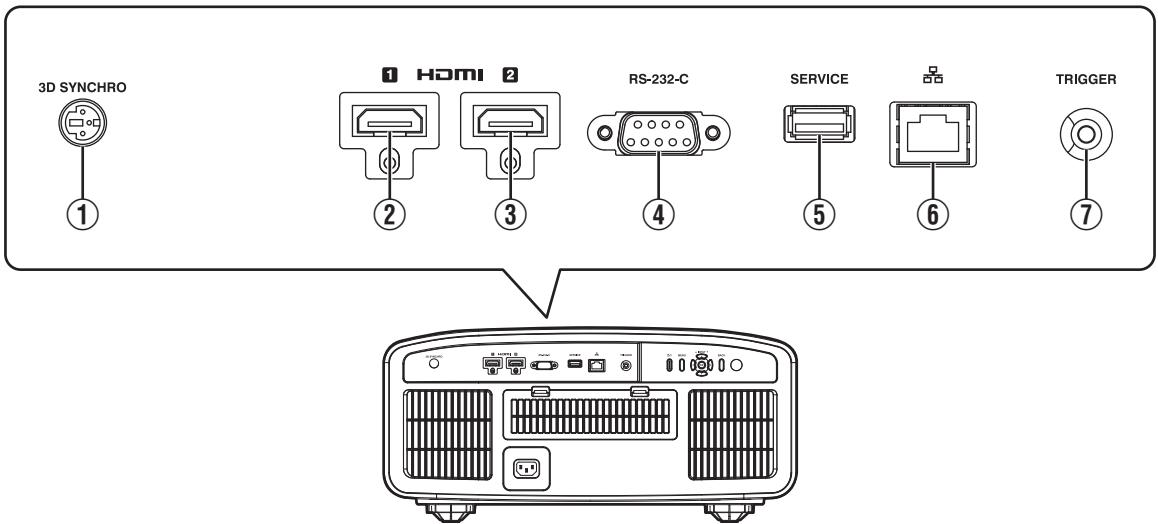

### ① [3D SYNCHRO] terminal

By connecting a 3D Synchro Emitter (sold separately) to this terminal, you can view 3D movies.

### ② [HDMI 1] input terminal

### ③ [HDMI 2] input terminal

For connecting to devices that support HDMI output. (P. 19)

It is fitted to the M3 lock hole. The depth of the screw hole is 3 mm (0.1 in).

### ④ [RS-232C] terminal (D-sub 9-pin male)

The projector can be controlled by connecting a PC to this terminal.

### ⑤ [SERVICE] terminal

For updating the software using a commercially available USB flash drive.

### ⑥ [LAN] terminal (RJ-45)

The projector can be controlled by connecting it to a PC through the computer network for control commands to be sent to the projector.

### ⑦ [TRIGGER] terminal

Output terminal for DC 12 V, 100 mA power supply. It is used for sending output signals to control devices such as an elevating screen that is equipped with a trigger function.

Note that improper connection may damage the projector. (Tip=DC +12 V, Sleeve=GND)

## Remote Control

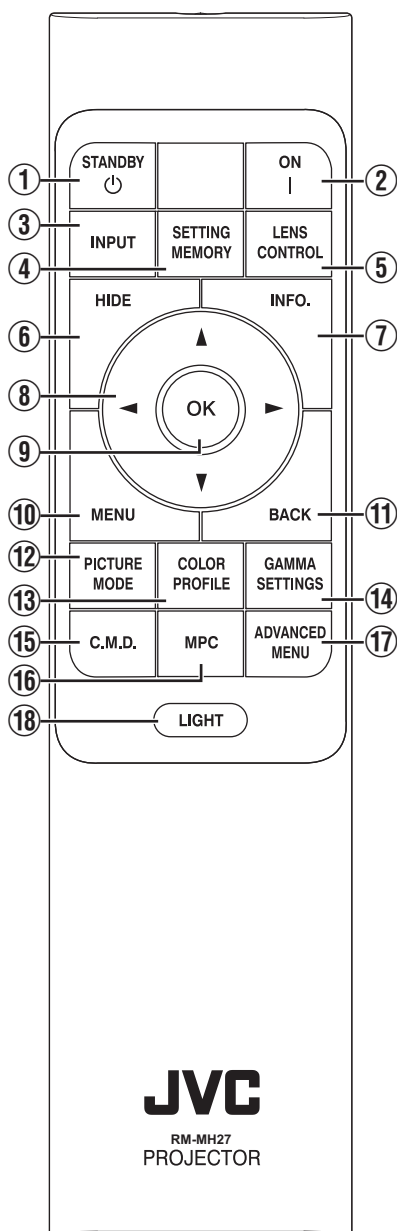

- ① [STANDBBY]**  
Turns off the power. (P. 23)
- ② [ON]**  
Turns on the power. (P. 22)
- ③ [INPUT]**  
Switches the input to [HDMI 1] or [HDMI 2]. (P. 22)
- ④ [SETTING MEMORY]**  
Displays the installation mode selection menu.
- ⑤ [LENS CONTROL]**  
For adjusting focus, zoom, and shift. (P. 24)
- Pressing the button each time switches the setting in the following sequence: "Focus" → "Zoom" → "Shift"...
- ⑥ [HIDE]**  
Hides the image temporarily. (P. 22)
- ⑦ [INFO.]**  
Displays the information menu. (P. 63)
- ⑧ [▲▼◀▶] keys**  
For selecting an item.
- ⑨ [OK]**  
Confirms a selected item.
- ⑩ [MENU]**  
Displays the menu, or hides the menu if it is displayed.
- ⑪ [BACK]**  
Returns to the previous menu.
- ⑫ [PICTURE MODE]**  
Displays the picture mode selection menu. (P. 29)
- ⑬ [COLOR PROFILE]**  
Displays the color profile selection menu. (P. 30)
- ⑭ [GAMMA SETTINGS]**  
Displays the gamma setting menu.
- ⑮ [C.M.D.]**  
Displays the frame interpolation selection menu. (P. 43)
- ⑯ [MPC]**  
Displays the MPC setting menu. (P. 35)
- ⑰ [ADVANCED MENU]**  
Pressing the button each time toggles the menu display in the following sequence: "Picture Mode" → "Color Profile" → "Color Temp." → "Motion Control".
- ⑱ [LIGHT]**  
Illuminates the buttons on the remote control.

## Loading Batteries into the Remote Control

### Loading the batteries

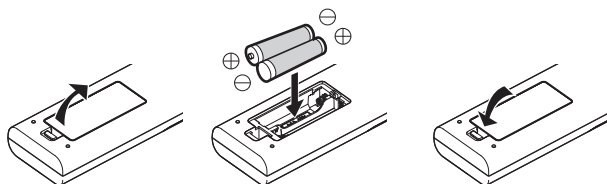

### Removing the batteries

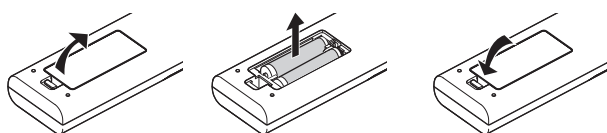

- If the remote control has to be brought closer to the unit to operate, it means that the batteries are wearing out. Replace the batteries with new ones (AAA).
- Insert the batteries according to the  $\oplus$   $\ominus$  marks. Be sure to insert the  $\ominus$  end first. When removing the battery, do so from the  $\oplus$  end.
- If an error occurs while using the remote control, remove the batteries and wait for five minutes. Load the batteries again and operate the remote control.

### CAUTION

- Do not put the remote control in a place with an exposure to direct sun light or high temperature. It may be deformed due to heat, or the internal components may be adversely affected resulting in fire hazard.
- Remove the batteries from the remote control when storing the remote control. Storing the remote control for a prolonged period without removing the batteries can cause battery leakage.
- Risk of explosion if battery is replaced by an incorrect type. Dispose of used batteries according to the instructions.
- If you want to dispose of the battery, please consider the collection systems or facilities for appropriate recycling.

## Effective Range of Remote Control Unit

When aiming the remote control toward the sensor on this unit (front or rear), ensure that the distance to the sensor is within 7 m.

If the remote control fails to work properly, move closer to this unit.

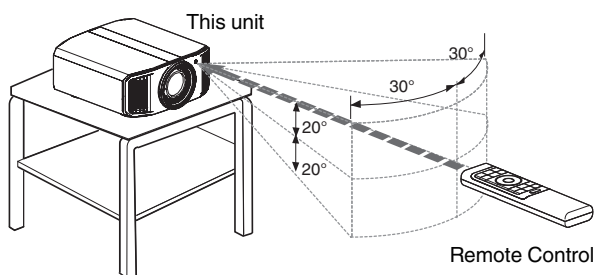

### Control through reflection off a screen, etc.

Ensure that the total of distance A (between this unit and the screen) and distance B (between the remote control and the screen) is within 7 m.

- \* As the efficiency of signals reflected from the remote control unit varies with the type of screen used, the operable distance may decrease.

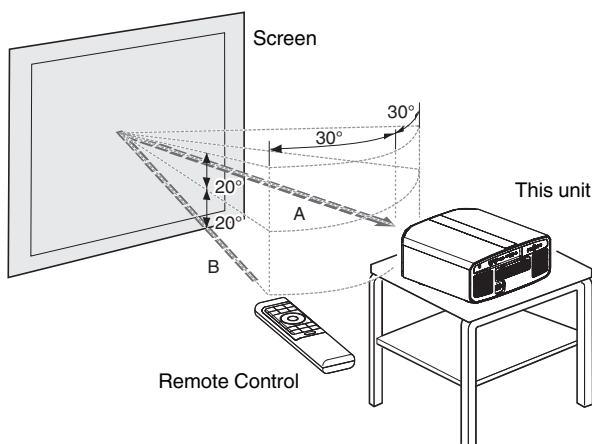



## Menu

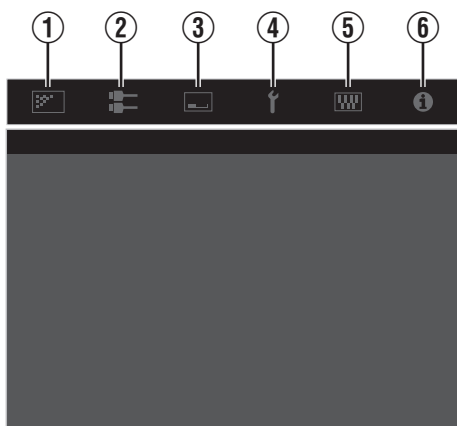

Select the icon at the top of the menu to display its corresponding setting item as shown below.

### ① Picture Adjust



### ② Input Signal



### ③ Installation



### ④ Display Setup



### ⑤ Function



### ⑥ Information



# Installing the Projector

## Precautions during Installation

Please read the following carefully before installing this unit.

### When carrying this unit

This unit is heavy in weight. Please ensure that there are at least two persons carrying it.

### Do not install at the following

This unit is a precision device. Please refrain from installing or using it at the following locations. Otherwise, it may cause fire or malfunction.

- Dusty, wet and humid places
- Places subject to oily smoke or cigarette smoke
- On top of a carpet or bedding, or other soft surfaces
- Places exposed to direct sunlight
- Places with a high or low temperature
- Do not install this unit in a room that is oily or subject to cigarette smoke. Even a small quantity of smoke or oiliness can have a long-term impact on this unit.
- \* This unit produces a great amount of heat, and is designed to take in cool air to cool its optical components. Using the unit at the above locations may cause dirt to attach to the light path, thereby resulting in dark images or dull colors.
- \* Dirt that sticks to the optical components cannot be removed.

### Maintain clearance from the wall, etc.

As the unit discharges a large amount of heat, install it with adequate clearance from the surroundings as shown below.

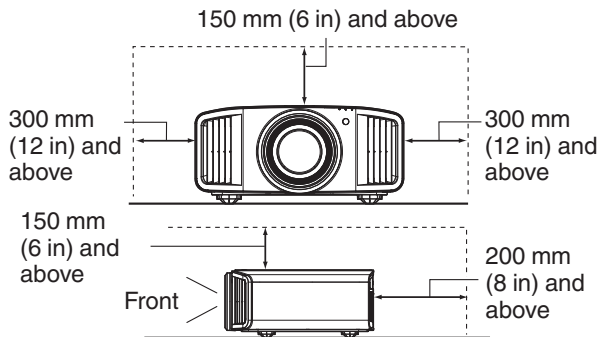

Leave the front area of the unit unblocked. If there is any obstructing object in front of the exhaust vent, hot air will flow back to the unit and cause it to heat up. Hot air flowing out of the unit may cast shadows on the screen (heat haze phenomenon).

### Using the unit

This unit uses a projection lamp, which will heat up when in use.

Please refrain from projecting in the following circumstances. Otherwise, it may cause fire or malfunction.

- Projection with the unit stood vertically

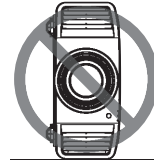

- Projection with the unit inclined at an angle

Horizontal direction: within  $\pm 5^\circ$

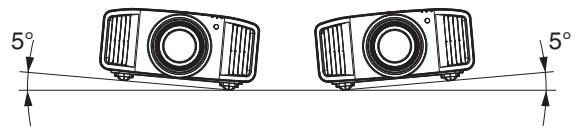

Vertical inclination: within  $\pm 10^\circ$

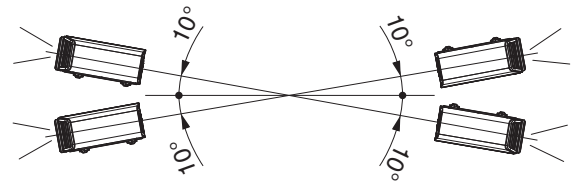

- Malfunction may occur if the angle is not set within the above-mentioned range.

### Installing the screen

Install the unit and the screen such that they are perpendicular to each other.

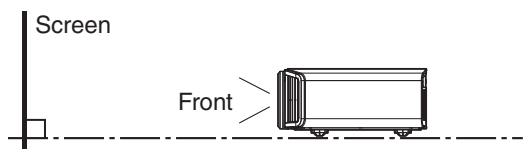

- Please choose a screen material with non-uniform patterns. Uniform patterns such as checks may cause interference patterns to occur.
- In this case, you can change the size of the screen to make the interference patterns less noticeable.

### Using the projector at a high altitude

When using this unit at a location that is higher than 900 m (3,000 ft) above sea level (low air pressure), set the "High Altitude Mode" to "On". (P. 63)

## Precautions during Mounting

### Securing (mounting) the projector

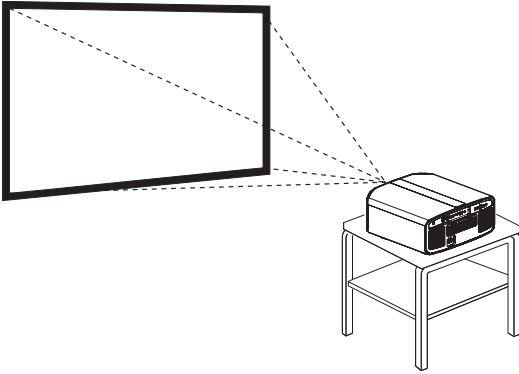

- When this unit is to be mounted to a fixed position for use, install it horizontally.
- Make sure to secure the main unit to prevent accidents such as during an earthquake.

### Securing with screws

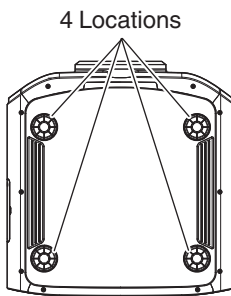

Remove the four feet at the bottom, and fasten using the screws (M5 screws, 15 to 25 mm).

- \* Using screws other than those designated may cause the unit to break down.

### Securing the projector (ceiling mount)

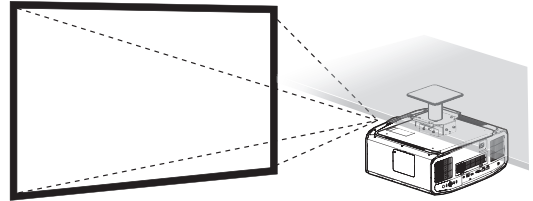

- Be sure to ask your dealer to install the unit for you. Installing the unit on your own may cause the unit to fall resulting in injury.
- Take the necessary actions to prevent the main unit from falling off such as during an earthquake.
- Regardless of the warranty period, JVC is not liable for any product damage caused by mounting the unit with non-JVC ceiling fittings or to an environment that is not suited for ceiling mount.
- When using the unit with it suspended from a ceiling, pay attention to the surrounding temperature. When a heater is in use, the temperature around the ceiling may be higher than expected.
- To attach the unit to the ceiling mount bracket, set the torque between the range of 1.5N m to 2.0N m. Tightening with torque exceeding the above range may cause damage to the unit, which may result the unit to fall.
- When reusing the ceiling mount bracket of an old model, consult the specialist to check if there are any issues with the surrounding space and increase in weight.
- Install the outlet at an accessible height to unplug from the wall. Or install the circuit breaker at an accessible height to shut down the projector. If you need information, please consult your authorized dealer or specialist.

# Adjusting the Position

## Adjusting the elevation angle of the projector

The height and inclination of the unit (0~5 mm (0~0.2 in)) can be adjusted by turning the feet. Lift the unit and adjust the four feet.

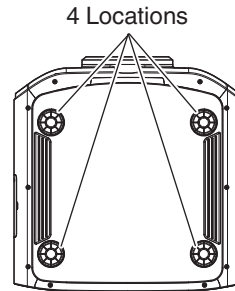
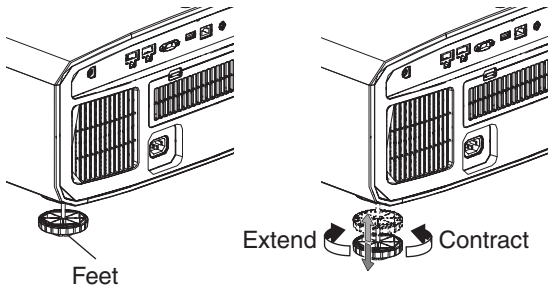

## Adjusting the position of the image

By using the lens shift feature of this unit, you can shift the image upward/downward or to the left/right. Set it to your preferred position.

➔ “Adjusting the Lens According to the Projection Position” (P. 24)

### Horizontal Position

Vertical Position: 0% (Center)

Up to about 43% **RS3000** and 34% **RS2000** **RS1000** of the projected image \*

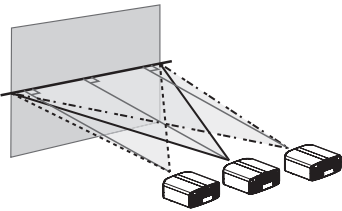

### Lens Shift Range (16:9)

**RS3000**

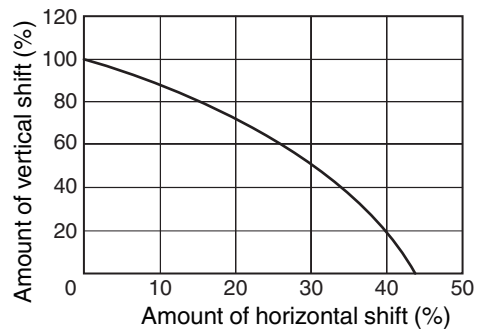

### Vertical Position

Horizontal Position: 0% (Center)

Up to about 100% **RS3000** and 80% **RS2000** **RS1000** of the projected image \*

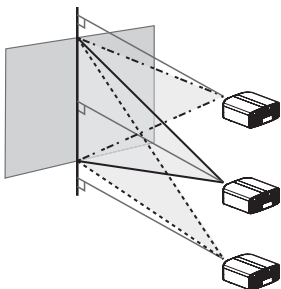

**RS2000** **RS1000**

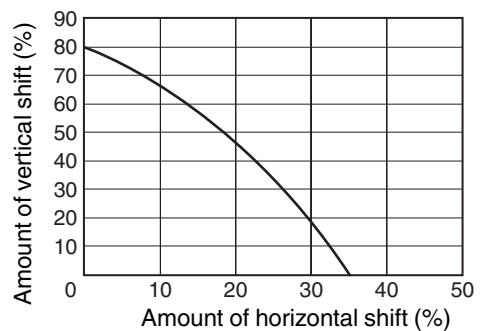

\* 16:9 image

- The maximum vertical shift varies with the amount of horizontal shift. Similarly, the maximum horizontal shift also changes with the amount of vertical shift.
- The values on the graph are intended as a guide. Use them for reference during installation.

# Connecting the Projector

- Do not turn on the power until connection is complete.
- The connection procedures differ according to the device used. For details, please refer to the instruction manual of the device to be connected.
- This projector is used for projecting images. To output the audio of connected devices, please connect a separate audio output device, such as an amplifier or speaker.
- The images may not be displayed depending on the devices and cables to be connected.  
Use a high-speed HDMI cable (sold separately) that is HDMI-certified.  
When using a standard cable, you are recommended to set the resolution of the equipment transmitting the video to 1080i or lower.
- Also, please refer to “HDMI 2 EDID”P. 52.
- Some cables cannot be connected to this unit due to the size of their connector cover.

## Connecting to the HDMI Input Terminal (Digital Input)

### Connecting via HDMI cable

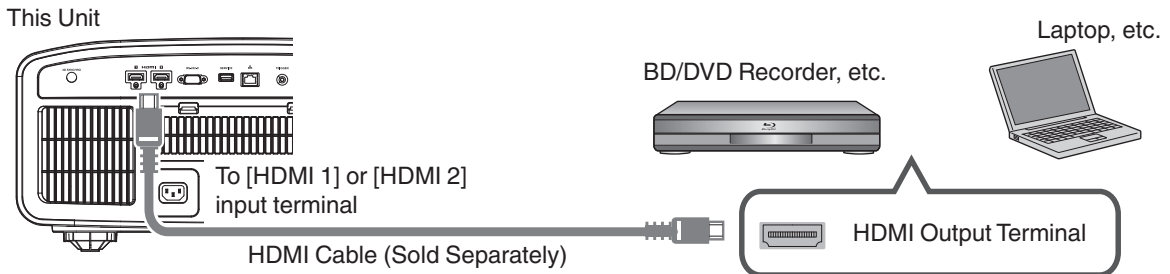

- If noise occurs, move the laptop away from this unit.

### Connecting through an AV amplifier

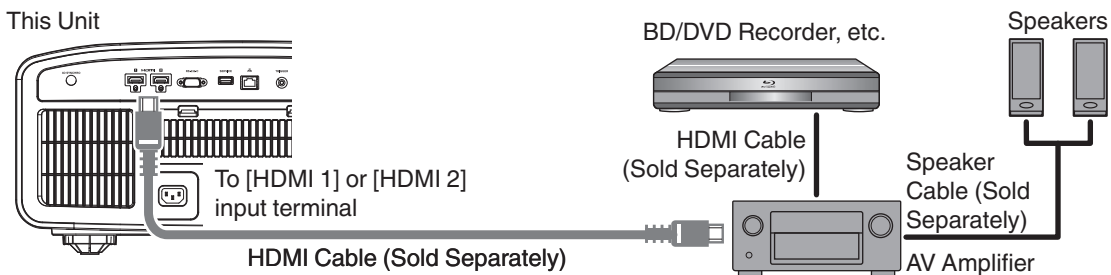

- If the source device is connected to the projector through an intermediate device such as an AV amplifier or divider, the video image may not appear depending on the specifications of the intermediate device.  
In this case, connect the source device directly to the projector, and check whether the video image is displayed.



## Connecting via HDMI-DVI conversion cable

This Unit

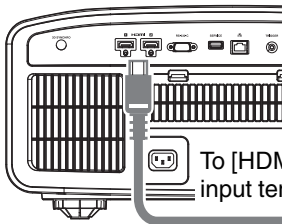

To [HDMI 1] or [HDMI 2]  
input terminal

HDMI-DVI Conversion Cable (Sold Separately)

Desktop PC, etc.



DVI Output Terminal

- If noise occurs, move the desktop PC away from this unit.
- If the video is not displayed, try to reduce the length of the cable or lower the resolution of the video transmitting equipment.

## Connecting to the LAN Terminal

This Unit

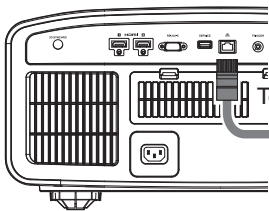

To [LAN] Terminal

Connection Cable  
(Sold Separately)

Desktop PC, etc.



Network



Server

- The network is used to control this unit. It is not used for sending or receiving video signals.
- Please contact your network administrator for information concerning the network connection.
- Set "ECO Mode" to "Off" if LAN communication is performed in the Standby mode. (P. 61)
- For more information on control, please refer to "External Control" P. 73.

## Connecting to the RS-232C Terminal

This Unit

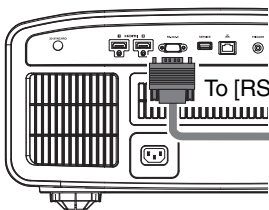

To [RS-232C] Terminal

RS-232C Connection  
Cable (Sold Separately)

Laptop, etc.



RS-232C Terminal

- Set "ECO Mode" to "Off" if RS-232C communication is performed in the Standby mode. (P. 61)
- For more information on control, please refer to "External Control" P. 73.

## Connecting to the TRIGGER Terminal

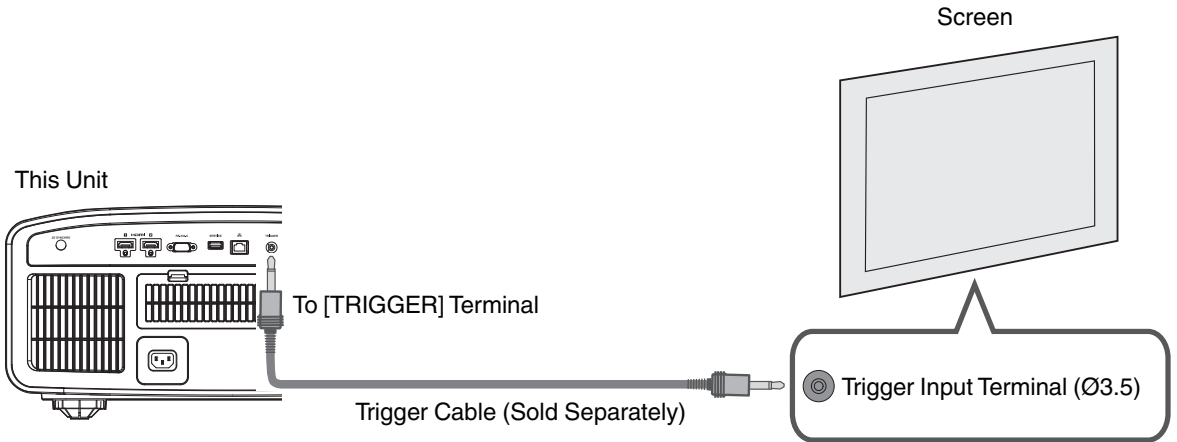

- Do not use it to supply power to other devices.
- Connecting to the audio terminal of another device may cause the device to malfunction or break down.
- Using beyond the rated value will cause the unit to malfunction.
- The trigger terminal outputs a voltage of 12 V. Exercise adequate caution to prevent short circuit.
- The factory setting is "Off". To change the setting, configure the "Trigger" item in the menu (P. 61).

## Connecting the Power Cord (Supplied Accessory)

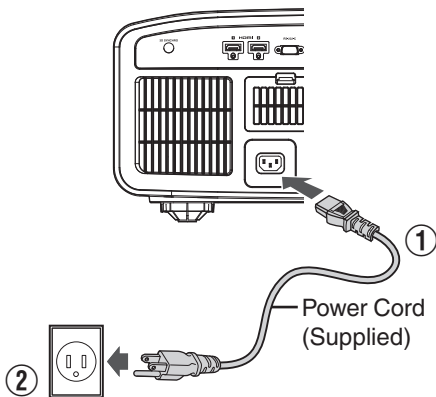

- ① Connect the power cord supplied to the power input terminal on the main unit
- ② Insert the supplied power plug into the wall outlet.

## ⚠ Precautions to prevent fire and electric shock

- The power consumption of this unit is large. Please connect it directly to the wall outlet.
- When you are not using the projector, please unplug the power cord from the outlet.
- Connect it using only the power cord supplied.
- Do not use a voltage other than the indicated power voltage.
- Do not damage, break or modify the power cord. Do not place a heavy object on the power cord, or heat or pull it. Doing so may damage the power cord.
- Do not unplug the power cord with wet hands.

# Viewing Videos

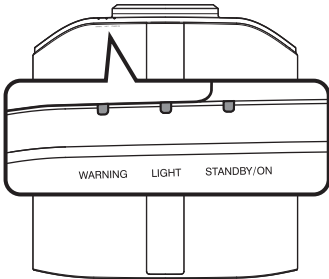
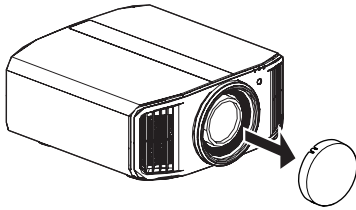

Remote Control

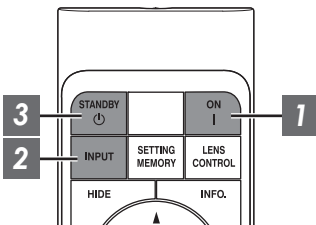

This unit

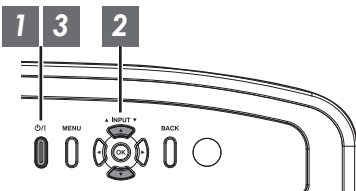

## MEMO

- Make sure to remove the lens cover.
- Connect the power cord, and ensure that the “STANDBY/ON” indicator lights up in red.
- During standby in the “ECO Mode”, the “STANDBY/ON” indicator does not light up even when the power cord is correctly connected. In this case, cancel the standby mode by pressing any button on the remote control unit, or use the  $\odot$ /I button on the projector unit when you are turning on the power.

### 1 Turn on the power

Remote control: press the I [ON] button

Projector unit: press the  $\odot$ /I button

- The “STANDBY/ON” indicator light switches from red (light off in “ECO Mode”) to green (light goes off after the unit starts up).

“STANDBY/ON” lights up (red)  
In standby state



“STANDBY/ON” lights up (green)  
During lamp startup



“STANDBY/ON” light off  
When in “ECO Mode”



### 2 Choose the image to project

Remote control/projector unit: press the [INPUT] button to switch the input

- Play back the selected device to project the image.

To hide the image temporarily

Press the [HIDE] button on the remote control

- The “STANDBY/ON” indicator light starts to blink in green.
- Press the [HIDE] button again to resume display of the image.
- The power cannot be turned off when the image is temporarily hidden.

### 3 Turn off the power

Remote control: press the ⏻ [STANDBY] button

Projector unit: press the ⏻/I button

- While the “Are you sure you want to turn off?” message is displayed, press the button again.
- The lamp turns off, and the “STANDBY/ON” indicator switches from a green light to a red blinking light.
- After the light goes off, the fan will run for about 60 seconds to cool down the lamp (Cool-down mode). Do not disconnect the power cable while cooling is in progress.
- After about 60 seconds, the “STANDBY/ON” indicator switches from a blinking red to a solid red light.

“STANDBY/ON” blinking (red)  
In the Cool-down mode



“STANDBY/ON” lights up (red)  
In standby state



- Attach the lens cover.

### CAUTION

- The power cannot be turned off within approximately 80 seconds after it has been turned on.
- The power cannot be turned on again while cooling is in progress (60 seconds).
- Pull out the power plug when the unit is not to be used for a prolonged period of time.
- If the indication of indicator differs from the description, refer to “Indicator Display on the Main Unit”P. 84 for details.

# Adjusting the Projector Screen

## Adjusting the Lens According to the Projection Position

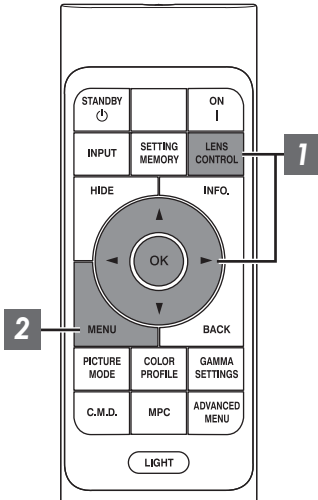

1 Press the [LENS CONTROL] button, and use the [▲▼◀▶] keys to adjust Focus, Zoom (screen size), and Shift (screen position)

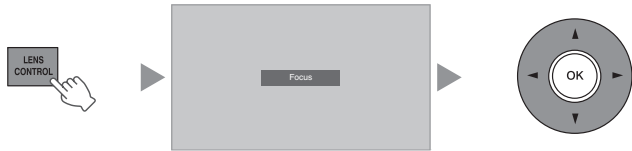

- Pressing the [LENS CONTROL] or [OK] button each time switches the mode in the following sequence: "Focus" → "Zoom" → "Shift" → "Focus"...
- Operation of the lens control feature is disabled when the lens lock is set to "On". (P. 54)
- For more detailed information, please refer to "Lens Control" P. 54.

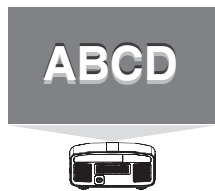

Focus Adjustment

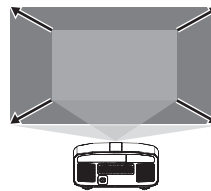

Zoom (Screen Size) Adjustment

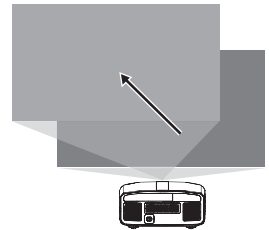

Shift (Screen Position) Adjustment

2 Press the [MENU] button once, or the [BACK] twice, to end adjustment



## Setting Screen Correction

### 1 Set Screen Adjust

By selecting the optimal correction mode according to the characteristics of the screen in use, corrections can be performed to reproduce natural images with balanced colors.

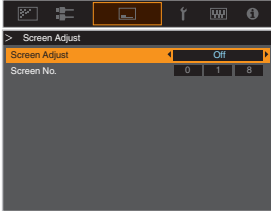

- This item is not available when “Color Profile” is set to “Off”.
- For information on the screen and the corresponding correction mode, please visit our website.

<http://www3.jvckenwood.com/english/projector/screen/>

### MEMO

- You can utilize the optional optical sensor and dedicated projector calibration software to make finer adjustments.  
For details on the dedicated projector calibration software, please visit our website.

<http://www3.jvckenwood.com/english/download/>

## Adjusting the Screen Size (Aspect)

The screen size of the projected image can be adjusted optimally according to the original screen size (aspect) that has been input.

- 1 Press the [MENU] button to display the menu
- 2 Select “Installation” → “Aspect” in the menu, then select the setting and press [OK]

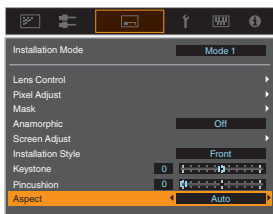

Setting	Description
Zoom	Magnifies the input image horizontally to the maximum while maintaining its aspect ratio for display. Part of the image that runs off the edge vertically will not be displayed.
Auto	Magnifies the input image horizontally or vertically to the maximum while maintaining its aspect ratio for display.
Native	Any image below 1920x1080 and 2048x1080 will be scaled 4 times the native resolution of the source. Any source above 1920x1080 will be shown without any scaling. *2048x1080 the exception.

- 3 Press the [MENU] button to exit

### Example of input image and screen size

Setting \ Input Image Size	Zoom	Auto	Native
720x480			
1920x1080			

# Viewing 3D Movies

By using the 3D Glasses (PK-AG1, PK-AG2, or PK-AG3) and 3D Synchro Emitter (PK-EM1 or PK-EM2), both sold separately, you can enjoy 3D video images.

- For 3D Glasses and 3D Synchro Emitter that are compatible with this unit, please refer to “Optional Accessories”P. 9.

## Installing the 3D Synchro Emitter

- 1 Connect 3D Synchro Emitter to the [3D SYNCHRO] terminal on the main unit

### Installation Example

This Unit

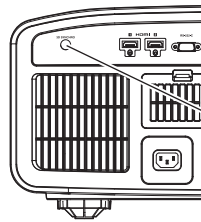

3D Synchro Emitter  
PK-EM2



3D Glasses  
PK-AG3

### CAUTION

- If PK-EM1 is used, adjust the position of the 3D Synchro Emitter such that the 3D Glasses can receive the signal from the 3D Synchro Emitter.  
For more details, please refer to the instruction manual of PK-EM1.

## Viewing 3D Movies

1

Connect this unit to a 3D-compatible HDMI device, and turn on the power to play back the 3D video image

- For details on how to play back 3D video images, please refer to the instruction manual of the player or recorder in use.
- This unit supports the following 3D formats.
  - Frame packing
  - Side-by-side
  - Top-and-bottom

Setting the 3D format

- ① **Select “Input Signal” → “3D Setting” → “3D Format” in the menu to switch the format**

Format	Description
Auto	Automatically determines and sets the format upon receiving 3D signal.
Side by Side	Select this setting if the 3D input signal is of the side-by-side format.
Top and Bottom	Select this setting if the 3D input signal is of the top-and-bottom format.
2D	Select this setting if 2D images are falsely recognized as 3D ones.

- \* If a signal cannot be displayed as 3D image, selecting the format does not switch the signal to a 3D image.  
For more information on possible input signals, please refer to “Types of Possible Input Signals”P. 83.
- \* In the default setting, “3D Format” is set to “Auto” for automatic projection of 3D images.

2

Turn on the power of the 3D Glasses and put them on

- The PK-AG1 powers on automatically.

## Adjusting 3D Movies

3D video images may appear differently to different viewers. It may also be affected by your physical condition at the time of viewing. You are therefore recommended to adjust the video images accordingly.

1

Select “Input Signal” → “3D Setting” from the menu

### Adjusting parallax (Parallax)

Adjust the displacement of the image for the left and right eyes separately to obtain the best 3D effect.

- To do so, use the ◀▶ keys to move the cursor.
- Setting range: -15 to +15

### Adjusting crosstalk (Crosstalk Cancel)

Double images (overlapping of the left image with the one on the right or vice versa) can be reduced to deliver a clear quality.

- To do so, use the ◀▶ keys to move the cursor.
- Setting range: -8 to +8

2

Press the [MENU] button to exit

# Selecting an Image Quality According to the Video Type

## Setting the Picture Mode

You can adjust the image quality according to the type of video image you are viewing.

**1** Press the [PICTURE MODE] button, use the [▲▼] keys to select “Picture Mode” and press [OK]

- You can configure more detailed setting items by pressing the [MENU] button to display the menu, followed by selecting “Picture Adjust” → “Picture Mode” and pressing the [OK] button. (P. 46)

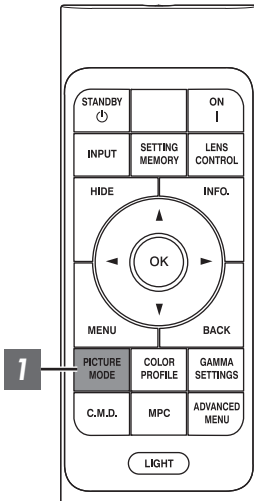

Item	Description
Natural	Image quality that focuses on natural color and gradation reproduction. Suitable for drama footage, etc.
Cinema	Reproduces the image in vivid colors. Suitable for all movies.
HDR10	Making full use of the wide color gamut and contrast, this mode is suited for viewing HDR10 content such as Ultra HD Blu-ray and streaming service. (This unit automatically switches to this mode by default when HDR10 signal is detected.)
HLG	Image quality suited for viewing content produced in Hybrid Log-Gamma, a HDR standard for broadcasting. (This unit automatically switches to this mode by default when Hybrid Log-Gamma signal is detected.)
Film <b>RS3000</b> <b>RS2000</b>	Reproduces faithfully the texture of movie films.
THX <b>RS3000</b>	Image quality certified by THX.
User 1 to User 6	Enables user-defined image quality data to be saved and retrieved.

## Setting the Color Profile

By setting the “Color Profile” (color space information) according to the “Picture Mode”, you can fine-tune the image quality according to the movie you are viewing.

1 After configuring “Picture Mode” (P. 29), press the [COLOR PROFILE] button, use the [▲▼] keys to select “Color Profile”, followed by pressing [OK]

- You can also perform the setting by pressing the [MENU] button to display the menu followed by selecting “Picture Adjust” → “Color Profile”.
- The selectable “Color Profile” settings vary according to “Picture Mode”.

### “Color Profile”

Color Profile	Description
BT.709	Color space that is suitable for viewing BT.709 color space contents.
BT.2020 <b>RS3000</b> <b>RS2000</b>	Color space that is suitable for viewing BT.2020 color space contents.
DCI	Color space that is suitable for viewing DCI color space contents.
Video	Color gamut that reproduces video footage such as dramas and live images in bright and vivid colors.
Anime. <b>RS3000</b> <b>RS2000</b>	Color space that is suitable for CG animation works. Ideal for animated works with bright colors.
Cinema	Original JVC cinema-specific color gamut that achieves a balance between increased brightness and color vividness.
HDR	Color space suitable for HDR content.
Film 1 <b>RS3000</b> <b>RS2000</b>	Color space that is close to the characteristics of Eastman Kodak Company movie films.
Film 2 <b>RS3000</b> <b>RS2000</b>	Color space that is close to the characteristics of FUJIFILM Corporation movie films.
THX <b>RS3000</b>	Color space of the THX standard.
Off	Disables color space adjustment.
Custom1 to Custom6	For saving the color profile data created using the projector calibration software.

## List of selectable “Color Profile” according to “Picture Mode”

Picture Mode	Color Profile
Natural	BT.709
	BT.2020 <b>RS3000</b> <b>RS2000</b>
	DCI
	Video
	Anime. <b>RS3000</b> <b>RS2000</b>
	HDR
Cinema	BT.709
	BT.2020 <b>RS3000</b> <b>RS2000</b>
	Cinema
	DCI
	Video
	HDR
HDR10 HLG	BT.709
	BT.2020 <b>RS3000</b> <b>RS2000</b>
	DCI
	HDR
Film <b>RS3000</b> <b>RS2000</b>	Film 1
	Film 2
THX <b>RS3000</b>	THX
User 1 to User 6	BT.709
	BT.2020 <b>RS3000</b> <b>RS2000</b>
	DCI
	Video
	Anime. <b>RS3000</b> <b>RS2000</b>
	Cinema
	HDR
	Off
	Custom1 to Custom6

## Adjusting to your Preferred Color (Color Management)

Based on the setting of the selected “Color Profile”, you can adjust each of the following colors according to your preference: Red, Yellow, Green, Cyan, Blue, and Magenta.

- 1 Press the [MENU] button to display the menu, followed by selecting “Picture Adjust” → “Color Profile” to display the “Color Profile” menu
- 2 Set “Color Management” to “On”, and press the [OK] button

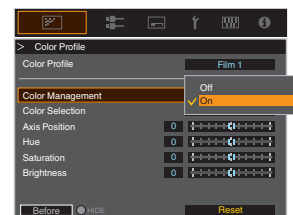

### 3 Adjust to the preferred color

- ① Select “Color Selection”, and press the ◀▶ keys to select the color to adjust
  - For color adjustment, select the color from the following: “Red”, “Yellow”, “Green”, “Cyan”, “Blue”, “Magenta”.
- ② Adjust the selected color

Item	Setting Range	Description
Axis Position	-30 to 30	Fine-tune the position of the central axis of the selected color.
Hue	-30 to 30	Adjusts the hue (color tone).
Saturation	-30 to 30	Adjusts the color saturation (vividness). -30 (dull) to +30 (vivid)
Brightness	-30 to 30	Adjusts the brightness. -30 (dark) to +30 (bright)

- Selecting “Reset” resets all the adjustment data.
- Pressing the [HIDE] button on the remote control enables you to check the image before adjustment. Press the [HIDE] button again to return to the adjustment screen.

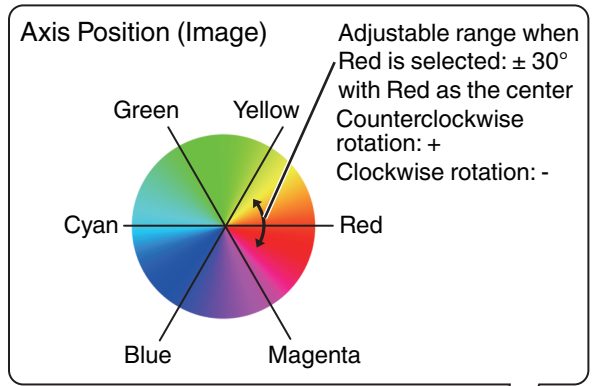

### 4 Press the [MENU] button to exit



# Viewing HDR Contents

When viewing HDR contents, making adjustments according to the content and viewing environment allows the images to be played back in higher quality.

## What is HDR content?

HDR (High Dynamic Range) refers to images with a significant difference in brightness between the highlight and shadow areas (dynamic range). It is a technology that enables faithful and realistic reproduction of the original colors as well as glitter and details of shadows that could not be expressed by the conventional SDR (Standard Dynamic Range). The international standard for HDR is set forth in the ITU-R (International Telecommunication Union – Radiocommunication Sector) BT.2100. Enhancements have been made in many aspects compared to ITU-R BT.709, which was the conventional Full HD standard.

HDR can largely be divided into two different formats, namely HDR10 which is employed by UHD-BD and video streaming services, and Hybrid Log-Gamma which is employed for broadcasting. Compared to the conventional SDR, the standard HDR format HDR10 delivers a higher resolution, higher luminance and higher gradation as well as a wider color gamut to reproduce images more realistically in combination with the wide dynamic range.

➔ “Original HDR Technology of JVC” (P. 33)

## Original HDR Technology of JVC

This unit is equipped with features for enjoying HDR images in better quality with ease.

### Auto HDR Picture Mode

An optimal picture mode is automatically selected for playing back HDR10 and Hybrid Log-Gamma contents. HDR contents cannot be displayed optimally if they are not viewed in a picture mode that supports HDR. This unit automatically switches to the optimal picture mode so you can enjoy viewing HDR images easily without the need to deal with the complex settings.

### Default Mode

Content Type	Default Picture Mode
HDR10 content	HDR10
Hybrid Log-Gamma content	HLG

It is also possible to change the setting such that the projector switches automatically to one of the user-defined picture modes between “User 1” and “User 6”.

\* The picture mode might not switch automatically depending on the playback content and player in use.

➔ “HDR Setting” (P. 52)

### HDR10 Mastering Information Display

Mastering information contained in the contents can be displayed when playing HDR10 contents such as those on UHD Blu-ray. With this information, you can be sure that HDR content is being played back. Also, based on the information of Max CLL and Max FALL, customized changes according to the content can be performed by adjusting the picture tone.

\* Mastering information might not be displayed depending on the playback content and player in use.

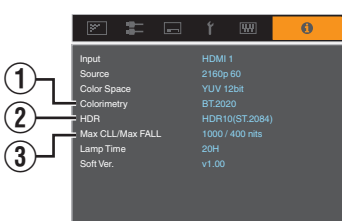

#### ① Colorimetry

Displays the color gamut information of the input signals.

#### ② HDR

Displays the gamma information when HDR packet is received.

#### ③ Max CLL/Max FALL

Displays the mastering information of the contents during HDR playback.

Max CLL: Maximum Content Light Level

Max FALL: Maximum Frame Average Light Level

➔ “ Information” (P. 63)

## Auto Tone Mapping

Grading varies diversely with the video work, with some content being made brighter and others darker. By using the “Auto Tone Mapping” function, gamma adjustment is performed automatically to achieve the optimal brightness based on the mastering information (Max CLL/Max FALL) contained in the HDR10 content. Also, by configuring the base brightness level in “Mapping Level”, you can enjoy the optimal picture quality according to the screen size and viewing environment.

\* “Auto Tone Mapping” may not be available depending on the playback content and player in use.

➔ “Set Auto Tone Mapping” (P. 40)



Auto Tone Mapping “Off”



Auto Tone Mapping “On”

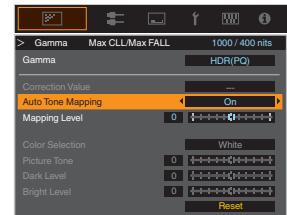

\* The photos are for illustrative purposes only.

## Manual HDR Gamma Adjustment

In addition to the “Auto Tone Mapping” function, gamma adjustment can also be performed manually on this unit. Fine-tuning according to the playback content and viewing environment is possible by using “Picture Tone” to determine the overall brightness, “Dark Level” to adjust the gradation of shadows, and “Bright Level” to adjust the gradation of highlights.

➔ “Using Tone Mapping for Manual Adjustments” (P. 41)



Picture Tone : Adjust the overall brightness without losing the gradation of image.



Dark Level : Adjust the dark area of the image.



Bright Level : Adjust the bright area of the image.



# Adjusting Movies for Increased Detail and Sharpness (Multiple Pixel Control)

The new image-processing algorithm developed by JVC helps to create a natural impression that is sharper at areas in focus, and softer at areas that are not in focus, enabling you to enjoy highly expressive images with a greater sense of depth.

## 1 Press the [MPC] button to display the adjustment menu

- The setting can also be configured by selecting “Picture Adjust” → “MPC/e-shift” **RS3000**, “MPC Level” **RS2000** **RS1000** from the menu.

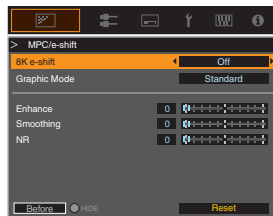

## 2 Make adjustments according to your preference based on the setting of the selected “Picture Mode”

- \* The factory setting varies with the “Picture Mode”.

Item	Setting	Description
8K e-shift <b>RS3000</b>	Off / On	Toggles the e-shift display to on or off.
Graphic Mode	Standard / High-res	Switches the MPC setting. It is recommended that this item be configured to Standard such as when viewing normal Blu-ray contents, and to “High-res” such as when viewing 4K resolution contents.
Enhance	0 to 10	Enhances the sharpness of the image.
Smoothing	0 to 10	Enhances the blurriness of the image for a softer effect.
NR	0 to 10	For reducing the noise of the video image.

- By increasing the setting range, you can expect enhanced effects.

## 3 Press the [MENU] button to exit

### Toggling between the States before and during Adjustment

Pressing the [HIDE] button on the remote control enables you to toggle between the states before adjustment and during adjustment.

# Fine-tuning the Image Quality

## Adjusting the Output Value of the Projected Image (Gamma)

You can adjust the output value of the projected image with respect to the video signal input.

### Example of gamma adjustment

The overall image appear brighter with respect to the original image, making the dark areas more visible.

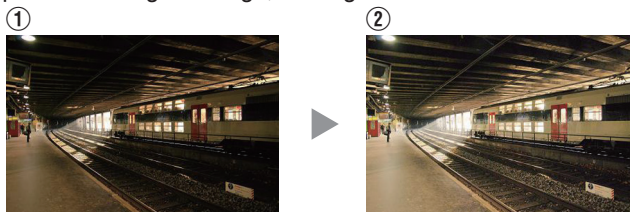
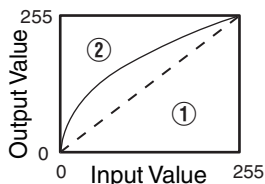

The photos are for illustrative purposes only.

Increases the contrast with respect to the original image, creating a greater sense of depth.

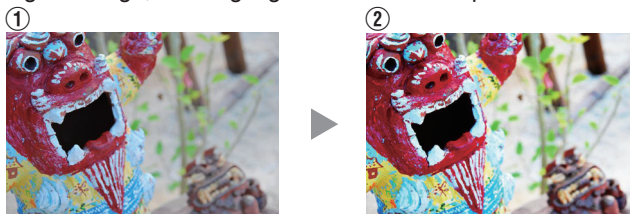
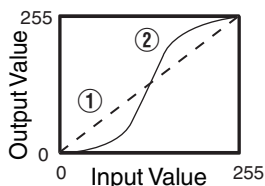

The photos are for illustrative purposes only.

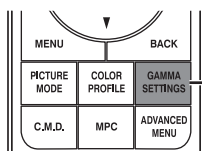

**1** Press the [GAMMA SETTINGS] button to display the gamma menu

**2** Select the “Gamma” to configure

- You can also perform the setting by pressing the [MENU] button to display the menu followed by selecting “Picture Adjust” → “Gamma”.
- The selectable “Gamma” settings vary according to “Picture Mode”.

## “Gamma”

Gamma		Description
When “Color Profile” is set to “Film 1” <b>RS3000</b> <b>RS2000</b>	Film 1	Image is close to the characteristics of Eastman Kodak Company movie films.
	Film 2	Places more emphasis on the gradation compared to the “Film 1” setting.
When “Color Profile” is set to “Film 2” <b>RS3000</b> <b>RS2000</b>	Film 1	Places more emphasis on the contrast compared to the “Film 2” setting.
	Film 2	Image is close to the characteristics of FUJIFILM Corporation movie films.
2.2		The gamma is set to “2.2”, “2.4” and “2.6” respectively.
2.4		
2.6		
Cinema 1		Places emphasis on the gradation.
Cinema 2		Places emphasis on the contrast.
HDR(PQ)		Suited for viewing HDR content such as UHD BD (HDR10).
HDR(HLG)		Suited for viewing HDR content such as HDR broadcast and streaming sources.
THX <b>RS3000</b>		Video of the THX standard.
Custom 1 to Custom 3		Enables fine adjustment of gamma according to preference.

## Selectable “Gamma” settings according to “Picture Mode”

Picture Mode	Gamma
Film <b>RS3000</b> <b>RS2000</b>	Film 1
	Film 2
	Custom 1 to Custom 3
Cinema Natural User 1 to User 6	HDR(PQ)
	HDR(HLG)
	2.2
	2.4
	2.6
	Cinema 1
	Cinema 2
	Custom 1 to Custom 3

Picture Mode	Gamma
HDR10	HDR(PQ)
	2.2
	2.4
	2.6
	Cinema 1
	Cinema 2
	Custom 1 to Custom 3
HLG	HDR(HLG)
	2.2
	2.4
	2.6
	Cinema 1
	Cinema 2
	Custom 1 to Custom 3
THX <b>RS3000</b>	THX

## Fine-tuning to the Preferred Gamma Setting

You can perform fine adjustments based on the selected gamma adjustment setting.

### 1 Press the [GAMMA SETTINGS] button to display the gamma menu

- You can also perform setting from “Picture Adjust”→“Gamma” in the menu.

### 2 Adjust to the preferred setting

- Select the color to be adjusted from “Color Selection” and adjust the “Picture Tone”, “Dark Level” and “Bright Level”.

#### Adjustment item and its setting

Item	Description	Setting
Color Selection	For selecting the color for adjusting “Picture Tone”, “Dark Level” and “Bright Level”.	White / Red / Green / Blue
Picture Tone	Adjusts the overall brightness automatically for a well-balanced result without compromising the gradation of the image.	-16 (darkens image for an underexposed effect) to +16 (brightens image for an overexposed effect)
Dark Level	Adjusts the dark areas of the input image. <ul style="list-style-type: none"><li>• To do so, use the ◀▶ keys to move the cursor.</li></ul>	-7 (darkens the shadows) to +7 (brightens the shadows)
Bright Level	Adjusts the bright areas of the input image. <ul style="list-style-type: none"><li>• To do so, use the ◀▶ keys to move the cursor.</li></ul>	-7 (darkens the highlights) to +7 (brightens the highlights)

## Selecting the Base Correction Value (Initial Value) for Adjustment

- Selecting one of the “Custom 1” to “Custom 3” settings in “Gamma” allows you to select the “Correction Value”.
- Select the base “Correction Value” for adjustment using the ◀▶ keys.
- The selectable correction values vary according to “Picture Mode”. (Refer to the table below.)

### List of selectable “Correction Value” according to “Picture Mode”

Picture Mode	Correction Value
Film RS3000 RS2000	Film 1
	Film 2
	Import
Cinema Natural User 1 to User 6	1.8
	1.9
	2.0
	2.1
	2.2
	2.3
	2.4
	2.5
	2.6
	Cinema 1
	Cinema 2
	HDR(PQ)
	HDR(HLG)
	Import

Picture Mode	Correction Value	
HDR10	1.8	
	1.9	
	2.0	
	2.1	
	2.2	
	2.3	
	2.4	
	2.5	
	2.6	
	Cinema 1	
	Cinema 2	
	HDR(PQ)	
	Import	
	HLG	1.8
		1.9
2.0		
2.1		
2.2		
2.3		
2.4		
2.5		
2.6		
Cinema 1		
Cinema 2		
HDR(HLG)		
Import		

#### When “Correction Value” is set to “Import”

- By selecting “Import” for “Correction Value”, the gamma data created externally can be selected as the base setting value for adjustment.
- The factory setting for “Import” is “2.2”.
- You can use the calibration software to customize the gamma data adjustment, and import the created gamma data.

Please check with your authorized dealer for details.

## Gamma Adjustment

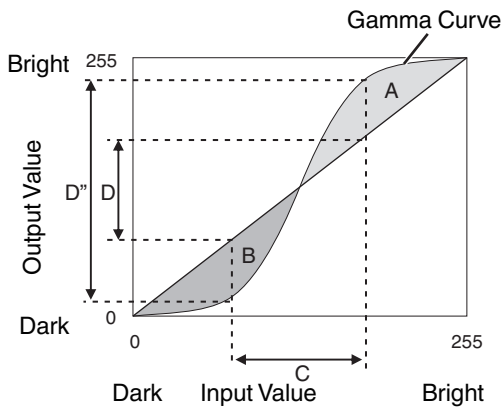

- When the gamma curve is a straight line:  
The brightness and contrast of the video input will be the same as that of the video output.
- Area for which the gamma curve is above the straight line (A):  
Video output appears brighter than the input.
- Area for which the gamma curve is below the straight line (B):  
Video output appears darker than the input.
- Area for which the slope of the gamma curve is steep (midtone) (C):  
The grayscale range of the video output becomes wider, and the contrast increases ( $D \rightarrow D'$ ).

## Set Auto Tone Mapping

**1** Press the [GAMMA SETTINGS] button to display the gamma menu

**2** Set “Auto Tone Mapping” to “On”

- The “Auto Tone Mapping” menu is displayed when “Gamma” is set to “HDR(PQ)” during playback of HDR contents, or when “Correction Value” of Gamma is set to “HDR(PQ)”.
- The information may not be displayed depending on the player and contents.
- Alternatively, you can set “Auto Tone Mapping” to “Off” to enable more fine-tuned adjustments.
  - ➔ “Using Tone Mapping for Manual Adjustments” (P. 41)

**3** Configure the base brightness in “Mapping Level”

- The “Auto Tone Mapping” setting is configured based on a 100" screen with a gain of 1.0 in total darkness.
- Adjust it in the positive direction if there is insufficient brightness in the viewing environment, and in the negative direction if it is too bright.

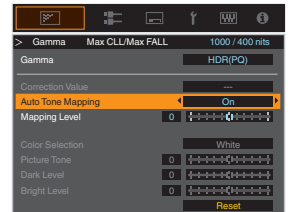



## Using Tone Mapping for Manual Adjustments

“HDR(PQ)” gamma is the PQ curve adopted by HDR10. Fine adjustments can be made according to the screen size and environment although the default settings for viewing with the projector have been adjusted to allow optimum viewing.

### Default settings when viewing HDR contents of this projector

Picture Mode : HDR10  
Gamma : HDR(PQ)  
Estimated Screen Size : 90 to 120 inch (screen gain 1.0)  
Estimated MaxCLL/MaxFALL : MaxCLL 1000 nits, MaxFALL 400 nits

### Picture tone adjustment method



When Picture Tone is set to “-”  
(The entire screen becomes dark.)

- Screen size is smaller than estimated
- MaxFALL/MaxCLL value is higher than estimated (P. 63)
- Screen becomes brighter in the course of viewing



When Picture Tone is set to “+”  
(The entire screen becomes brighter.)

- Screen size is bigger than estimated
- MaxFALL/MaxCLL value is lower than estimated (P. 63)
- Screen becomes darker in the course of viewing

### Bright/dark area adjustment method



(-) To enhance the contrast



(+) To make the dark area information more visible



(-) To enhance the gradation of highlight areas



(+) To enhance the contrast

## For users seeking to obtain a gamma curve that is more faithful to the original PQ curve

Our projectors have been adjusted to display the projector images on the screen in the optimal quality in the default setting based on the original PQ curve. For users who wish to obtain results more faithful to the original PQ curve, please adjust manually with reference to the values below.

### When clipping point is 400 nits

Picture Tone	+5
Dark Level	0
Bright Level	+7

### When clipping point is 1000 nits

Picture Tone	-7
Dark Level	0
Bright Level	+7

### When clipping point is 2000 nits

Picture Tone	-9
Dark Level	0
Bright Level	+7

### When clipping point is 4000 nits

Picture Tone	-13
Dark Level	0
Bright Level	+7

\* This product is designed for home use and we do not provide guarantee for commercial uses such as in mastering work.

## Reducing the After-image of Fast-moving Images (Motion Control)

### Low Latency

For changing the low latency setting.

You are recommended to set to "On" for contents requiring short latency such as games.

- 1 Press the [MENU] button to display the menu and select "Picture Adjust" → "Motion Control" → "Low Latency"

Setting	Description
Off	Does not perform the low latency setting.
On	Performs the low latency setting.

\* "Clear Motion Drive" cannot be set when "Low Latency" is set to "On".

\* Even when "Low Latency" is set to "On", delay will not become zero.

## Clear Motion Drive (C.M.D.)

Optimal interpolation according to the content is made possible with the new high-definition image interpolation technique.

For some scenes, interpolation may cause distortion in the image. In this case, set to "Off".

### Original Image

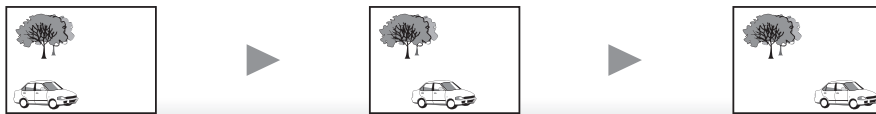

### Interpolation Enabled

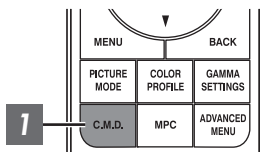
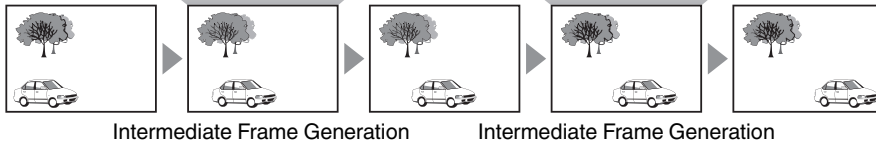

1 Press the [C.M.D.] button, use the [▲▼] keys to select a setting, followed by pressing [OK]

- You can also perform the setting by pressing the [MENU] button to display the menu followed by selecting "Picture Adjust"→"Motion Control"→"Clear Motion Drive".

Setting	Description
Off	Interpolation is not performed.
Low	Improves motion lag for movie type images.
High	Improves motion lag fast moving sports type images.
Inverse Telecine	60i/60p video images such as those of TVs and DVDs. Suitable for original images that are 24-frame film sources. • Does not function for 24p video images.

\* C.M.D. is the abbreviation for Clear Motion Drive.

\* This item cannot be set when "Low Latency" is set to "On".

## Motion Enhance

You can reduce motion blur with this function enhancing the response of D-ILA image devices. If the image outline is unnatural, set this item to "Off".

1 Press the [MENU] button to display the menu and select "Picture Adjust"→"Motion Control"→"Motion Enhance"

Setting	Description
Off	Does not perform correction.
Low	Reduces image blurring.
High	Further reduces image blurring than "Low".

# Adjustments and Settings in the Menu

Pressing the [MENU] button displays the menu.

Press the [▲▼◀▶] keys to select an item, followed by pressing the [OK] button to confirm the selection.

## List of Menu Items

### Picture Adjust

▶Picture Mode .....	P. 29
↳ Lamp Power .....	P. 46
↳ Aperture .....	P. 46
↳ User Name Edit .....	P. 46
▶Color Profile .....	P. 30
↳ Color Management .....	P. 31
▶Color Temp. ....	P. 47
▶Gamma .....	P. 36
↳ Auto Tone Mapping .....	P. 49
↳ Mapping Level .....	P. 49
↳ Picture Tone .....	P. 38
↳ Dark Level / Bright Level .....	P. 38
▶MPC/e-shift <b>RS3000</b> , MPC Level <b>RS2000</b> <b>RS1000</b> .....	P. 50
▶Motion Control .....	P. 42
▶Contrast .....	P. 50
▶Brightness .....	P. 50
▶Color .....	P. 50
▶Tint .....	P. 50

### Input Signal

▶Input Level .....	P. 51
▶Color Space .....	P. 51
▶3D Setting .....	P. 27
▶HDR Setting .....	P. 52
↳ HDR10 Auto Select .....	P. 52
↳ HLG Auto Select .....	P. 52
▶HDMI 2 EDID .....	P. 52

## Installation

▶Installation Mode .....	P. 53
▶Lens Control .....	P. 24
↳ Focus .....	P. 24
↳ Zoom .....	P. 24
↳ Shift .....	P. 24
↳ Image Pattern .....	P. 54
↳ Lock .....	P. 54
↳ Lens Center .....	P. 54
▶Pixel Adjust .....	P. 55
↳ Adjust .....	P. 55
↳ Adjust Area .....	P. 55
↳ Adjust Color .....	P. 55
↳ Adjust Pattern .....	P. 55
↳ Adjust Pattern Color .....	P. 55
↳ Adjust (Pixel) .....	P. 55
↳ Adjust (Fine) .....	P. 55
↳ Reset .....	P. 55
▶Mask .....	P. 59
▶Anamorphic .....	P. 59
▶Screen Adjust .....	P. 25
▶Installation Style .....	P. 59
▶Keystone .....	P. 60
▶Pincushion .....	P. 60
▶Aspect .....	P. 26

## Display Setup

▶Back Color .....	P. 60
▶Menu Position .....	P. 60
▶Signal Display .....	P. 60
▶Logo .....	P. 61
▶Language .....	P. 61

## Function

▶Trigger .....	P. 61
▶Off Timer .....	P. 61
▶ECO Mode .....	P. 61
▶Network .....	P. 62
▶Remote Code .....	P. 62
▶High Altitude Mode .....	P. 63
▶Factory Reset .....	P. 63
▶Software Update .....	P. 63

## Information

▶Information .....	P. 63
--------------------	-------



# Picture Adjust

## Picture Mode

You can adjust the image quality according to the type of video image you are viewing.

➔ "Setting the Picture Mode" (P. 29)

You can configure the following setting items by pressing the [MENU] button to display the menu, followed by selecting "Picture Adjust" → "Picture Mode" and pressing the [OK] button.

## Lamp Power

Switches the brightness of the lamp.

Setting	Description
Low	Brightness (low)
High	Brightness (high)

- The factory setting varies with the "Picture Mode".
- Continuous use at the "High" setting may cause the lamp to darken faster.

## Aperture

JVC has developed an image analysis algorithm, which analyzes the state of the video image in real time, and controls the aperture dynamically according to the image information.

This technology enables viewers to enjoy video images with enhanced contrast.

Setting	Description
Auto 1	Places emphasis on the gradation.
Auto 2	Image contrast is enhanced.
Manual	Does not perform dynamic control. Select this setting to perform adjustment manually.

- \*1 Manual adjustment is disabled in the "Auto 1" and "Auto 2" setting. To perform adjustment manually, select "Manual".
- \*2 When the setting is changed to Auto after performing manual adjustment, the value set manually will be used as the aperture value for Auto.

## User Name Edit

You can edit the "User 1" to "User 6" names in the Picture mode.

- Characters that are usable include alphabets (upper or lower case), numeric characters, and symbols.
- Enter not more than 10 characters.

Selection Cursor

Input Cursor

After entry is complete, select "OK" and press the [OK] button

## Color Profile

By setting the “Color Profile” (color space information) according to the “Picture Mode”, you can fine-tune the image quality according to the movie you are viewing.

➔ “Setting the Color Profile” (P. 30)

## Color Management

Each of the colors is adjustable according to the user’s preference.

➔ “Adjusting to your Preferred Color (Color Management)” (P. 31)

## Color Temp.

For setting the color temperature of the video image.

- When “Picture Mode” is set to “THX”, the setting is fixed at 6500K. **RS3000**
- The selectable “Color Temp.” settings vary according to “Picture Mode”.

### “Color Temp.”

Color Temp.	Description
Xenon 1 <b>RS3000</b> <b>RS2000</b>	Color temperature that reproduces the characteristics of a xenon lamp used in cinemas. <ul style="list-style-type: none"><li>• Xenon 1: A light source color that is emitted by a film projector</li><li>• Xenon 2: A light source color emitted by a projector used for digital cinema</li></ul>
Xenon 2 <b>RS3000</b> <b>RS2000</b>	
5500K	Increasing the value enhances the blue tone of the video image, while decreasing the value enhances the red tone.
6500K	
7500K	
9300K	
High Bright	Color temperature that gives priority to brightness.
Custom 1 to Custom 2	The color temperature of video images can be adjusted manually and saved as one of the three customized settings.
HDR10	Color temperature suitable for viewing HDR10 content. The default setting is 6500K.
HLG	Color temperature suitable for viewing HLG content. The default setting is 6500K.

## List of selectable “Color Temp.” according to “Picture Mode”

Picture Mode	Color Temp.
Film <b>RS3000</b> <b>RS2000</b>	Xenon 1 <b>RS3000</b> <b>RS2000</b>
	Xenon 2 <b>RS3000</b> <b>RS2000</b>
	Custom 1 to Custom 2
Cinema	5500K
	6500K
	7500K
	9300K
	Xenon 1 <b>RS3000</b> <b>RS2000</b>
	Xenon 2 <b>RS3000</b> <b>RS2000</b>
	High Bright
	HDR10
	HLG
Custom 1 to Custom 2	
Natural HDR10 HLG User 1 to User 6	5500K
	6500K
	7500K
	9300K
	High Bright
	HDR10
	HLG
	Custom 1 to Custom 2
	THX <b>RS3000</b>

### Correction Value

For setting the base color temperature for the adjustment of “Gain Red” / “Gain Green” / “Gain Blue” / “Offset Red” / “Offset Green” / “Offset Blue” when one of the “Custom 1” to “Custom 2” setting is selected in “Color Temp.”.

### Gain Red / Gain Green / Gain Blue

Adjusts each color in the bright parts of the video image.

- Setting range: -255 (reduces the red/green/blue tone) to 0 (no adjustment)

### Offset Red / Offset Green / Offset Blue

Adjusts each color in the dark areas of the video image.

- Setting range: -50 (reduces the red/green/blue tone) to 0 (no adjustment) to +50 (enhances the red/green/blue tone)
- Setting “Color Temp.” to “Custom 1”, “Custom 2” or “HDR” allows you to select and adjust a base correction value (initial value) for adjustment.
- The selectable correction values vary according to “Picture Mode”. (Refer to the table below.)



## List of selectable “Correction Value” according to “Picture Mode”

Picture Mode	Correction Value
Film <b>RS3000</b> <b>RS2000</b>	Xenon 1 <b>RS3000</b> <b>RS2000</b>
	Xenon 2 <b>RS3000</b> <b>RS2000</b>
Cinema	5500K
	6500K
	7500K
	9300K
	Xenon 1 <b>RS3000</b> <b>RS2000</b>
	Xenon 2 <b>RS3000</b> <b>RS2000</b>
	High Bright
Natural HDR10 HLG User 1 to User 6	5500K
	6500K
	7500K
	9300K
	High Bright

### Gamma

You can adjust the output value of the projected image with respect to the video signal input.

- ➔ “Adjusting the Output Value of the Projected Image (Gamma)” (P. 36)

### Correction Value

For setting the base gamma for the adjustment of “Picture Tone”, “Dark Level” and “Bright Level” when one of the “Custom 1” to “Custom 3” settings is selected in “Gamma”.

- ➔ “Fine-tuning to the Preferred Gamma Setting” (P. 38)

### Auto Tone Mapping

Gamma adjustment is performed automatically to achieve the optimal brightness based on the mastering information (Max CLL/Max FALL) contained in the HDR10 content.

- ➔ “Set Auto Tone Mapping” (P. 40)

### Mapping Level

Configure the base brightness for “Auto Tone Mapping”.

- ➔ “Set Auto Tone Mapping” (P. 40)

### Picture Tone

Adjusts the overall brightness automatically for a well-balanced result without compromising the gradation of the image.

- ➔ “Fine-tuning to the Preferred Gamma Setting” (P. 38)
- ➔ “Set Auto Tone Mapping” (P. 41)

### Dark Level / Bright Level

You can adjust the image quality to produce a sharp contrast in the brightness.

- ➔ “Fine-tuning to the Preferred Gamma Setting” (P. 38)
- ➔ “Set Auto Tone Mapping” (P. 41)

## MPC/e-shift **RS3000**, MPC Level **RS2000** **RS1000**

You can enjoy natural, expressive images with a stronger sense of depth.

- ➔ “Adjusting Movies for Increased Detail and Sharpness (Multiple Pixel Control)” (P. 35)

## 8K e-shift **RS3000**

Switches the display resolution.

- Setting values: On (8K), Off (4K)

## Graphic Mode

Switches the MPC setting.

It is recommended that this item be configured to “Standard” such as when viewing normal Blu-ray contents, and to “High-res” such as when viewing 4K resolution contents.

- Setting values: Standard and High-res

## Enhance

For adjusting the high-frequency areas. Increasing the value enhances the definition for a sharper image quality.

- Setting range: 0 to 10

## Smoothing

For adjusting the low-frequency areas. Increasing the value enhances the blurriness of the image for a softer effect.

- Setting range: 0 to 10

## NR

Prevents noise from becoming too pronounced.

- Setting range: 0 (weak) to 10 (strong)

## Motion Control

For reducing the after-image, which occurs in a fast-moving scene.

- ➔ “Reducing the After-image of Fast-moving Images (Motion Control)” (P. 42)

## Contrast

For adjusting the white level point to avoid clipping or over saturation.

- Setting range: -50 (little difference in brightness) to +50 (large difference in brightness)

## Brightness

For adjusting the black level point to avoid clipping or over saturation.

- Setting range: -50 (darker) to +50 (brighter)

## Color

For adjusting the color density of the video image.

- Setting range: -50 (lighter) to +50 (deeper)

## Tint

For adjusting the hue of the video image.

- Setting range: -50 (reddish) to +50 (greenish)



## Input Signal

### Input Level

For setting the dynamic range (gradation) of the video input.

If the image is not displayed properly even after selecting “Auto”, select an appropriate setting.

- If the dynamic range is not appropriate, the bright areas become overexposed, and the dark areas become underexposed.

Setting	Description
Auto	Sets the input signal level automatically.
16-235 (Video)	Select this setting if you are inputting video signals (dynamic range: 16 - 235).
0-255 (PC)	Select this setting if you are inputting PC signals (dynamic range: 0 - 255).
16-255 (S.White)	Select this setting when inputting Super White-compatible device signals (dynamic range: 16 - 255).

### Color Space

For setting the color space of the input signal.

If the image is not displayed properly even after selecting “Auto”, select an appropriate setting.

Setting	Description
Auto	Detects “YCbCr444”, “YCbCr422”, and “RGB” automatically.
YCbCr444	Select this setting when inputting YCbCr (4:4:4) video signals.
YCbCr422	Select this setting when inputting YCbCr (4:2:2) video signals.
RGB	Select this setting when inputting RGB video signals.

### 3D Setting

For setting 3D movies for viewing.

- ➔ “Viewing 3D Movies” (P. 27)

## HDR Setting

### HDR10 Auto Select

For configuring the automatic switching setting of "Picture Mode" when receiving HDR10 packets.

Setting	Description
HDR10	Automatically switches "Picture Mode" to "HDR10" when receiving HDR10 packets.
User 1 to User 6	Automatically switches "Picture Mode" to User 1 to User 6 when receiving HDR10 packets.
Off	"Picture Mode" does not switch automatically when receiving HDR10 packets.

### HLG Auto Select

For configuring the automatic switching setting of "Picture Mode" when receiving HLG packets.

Setting	Description
HLG	Automatically switches "Picture Mode" to "HLG" when receiving HLG packets.
User 1 to User 6	Automatically switches "Picture Mode" to User 1 to User 6 when receiving HLG packets.
Off	"Picture Mode" does not switch automatically when receiving HLG packets.

## HDMI 2 EDID

For changing the EDID mode of the [HDMI 2] terminal. Set to "A" under normal condition.

Images with resolution 1920x1080 or lower may not be displayed when some old devices are used.

In that case, connect to the [HDMI 2] terminal and set "HDMI 2 EDID" to "B".

- \* EDID (Extended Display Identification Data) refers to the information, such as supported resolutions, exchanged between devices.



# Installation

## Installation Mode

Collectively manages the setting values of “Lens Control”, “Pixel Adjust”, “Mask”, “Anamorphic”, “Screen Adjust”, “Installation Style”, “Keystone”, “Pincushion” and “Aspect”.

\* The lens position may be shifted slightly with respect to the position that was saved.

### Mode Select

For selecting the group to save and retrieve the setting values.

- Setting values: Mode 1 to Mode 10
- \* The name of the setting value can be changed using “Name Edit”.

### Name Edit

For editing the name of Installation Mode.

- Characters that are usable include alphabets (upper or lower case), numeric characters, and symbols.
- Enter not more than 10 characters.



### Mode Copy

For copying the setting values managed by the current Installation Mode to another mode.

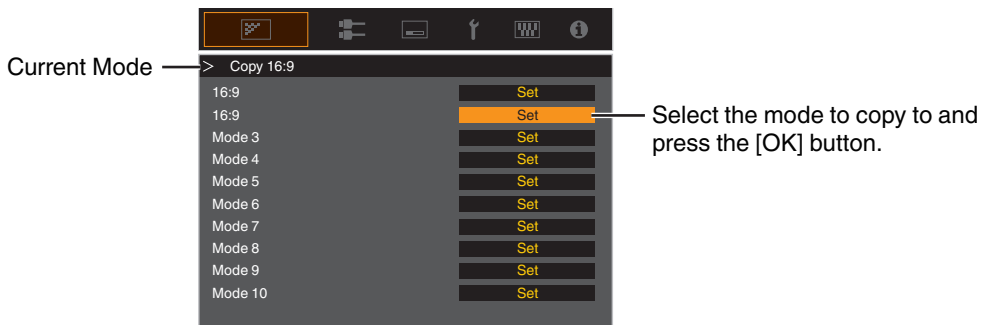

---

## Lens Control

### Focus / Zoom / Shift

For adjusting the lens according to the projection position

- ➔ “Adjusting the Lens According to the Projection Position” (P. 24)

### Image Pattern

For setting whether to display the lens adjustment pattern.

Setting	Description
Off	Displays external signals, and does not display the lens adjustment pattern.
On	Displays the lens adjustment pattern.

### Lock

For setting whether to lock or unlock the lens.

Setting to “On” to lock the lens allows you to preserve the adjustment status of the lens.

Setting	Description
Off	Does not lock the lens.
On	Locks the lens to prevent any erroneous operation on the adjustments. <ul style="list-style-type: none"><li>• Even when “On”, the lens will be in the mode selected by “Installation Mode”.</li></ul>

### Lens Center

Returns the lens position to the center.

## Pixel Adjust

For correcting the phase shifting between each RGB color by adjusting the pixel.

### Adjust

For setting the adjustment feature to On or Off.

### Adjust Area

Setting	Description
Whole	Adjusts the entire image.
Zone	Enables fine adjustment of each area by dividing the screen evenly into 10 vertical and horizontal zones.

### Adjust Color

For selecting the color to adjust (“Red” or “Blue”).

### Adjust Pattern

Setting	Description
Off	Displays the external signals without displaying the test pattern for adjustment.
On	Displays the test pattern for adjustment.

### Adjust Pattern Color

For setting the color of the adjustment pattern displayed during adjustment to “White” or “Yellow / Cyan”.

### Adjust (Pixel)

When “Adjust Area” is set to “Whole”, adjustment can be made by moving in units of one pixel on the screen of the color selected in “Adjust Color”.

- ➔ “Whole Adjust (Pixel) Operation Procedure” (P. 56)
- Adjustment cannot be made when “Adjust Area” is set to “Zone”.

Setting	Description
H (Horizontal)	Setting range: -2 (moves red/blue to the left) to +2 (moves red/blue to the right)
V (Vertical)	Setting range: -2 (moves red/blue downward) to +2 (moves red/blue upward)

### Adjust (Fine)

When “Adjust Area” is set to “Whole”, adjustment can be made by moving in units of 1/8 pixel on the screen of the color selected in “Adjust Color”.

- ➔ “Whole Adjust (Fine) Operation Procedure” (P. 57)

When “Adjust Area” is set to “Zone”, the screen is divided evenly into 10 vertical and horizontal zones, and fine adjustment of each area is possible.

- ➔ “Zone Adjust Operation Procedure” (P. 58)

Setting	Description
H (Horizontal)	Setting range: -31 (moves red/blue to the left) to +31 (moves red/blue to the right)
V (Vertical)	Setting range: -31 (moves red/blue downward) to +31 (moves red/blue upward)

### Reset

Restores all pixel adjustment data to the factory default.

## Whole Adjust (Pixel) Operation Procedure

For making general adjustments to slight color fringing in the horizontal/vertical directions of the video image.

- ① Set “Adjust Area” to “Whole”
- ② Select “Adjust Color” and “Adjust Pattern Color”
- ③ Select “Adjust (Pixel)”, and press the [OK] button
  - The Adjustment mode is activated, and the selected adjustment pattern and Adjustment (Pixel) window are displayed.

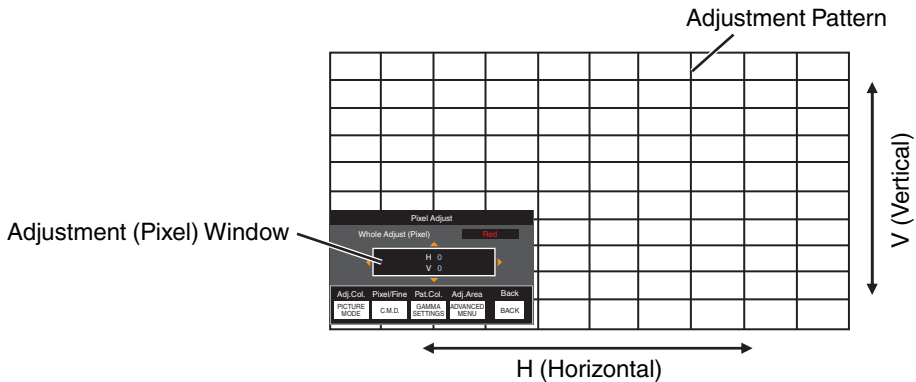

- ④ Use the [▲▼◀▶] keys to move and adjust the vertical and horizontal pixels of the entire zone

- The adjustment setting appears at the center of the Adjustment (Pixel) window.

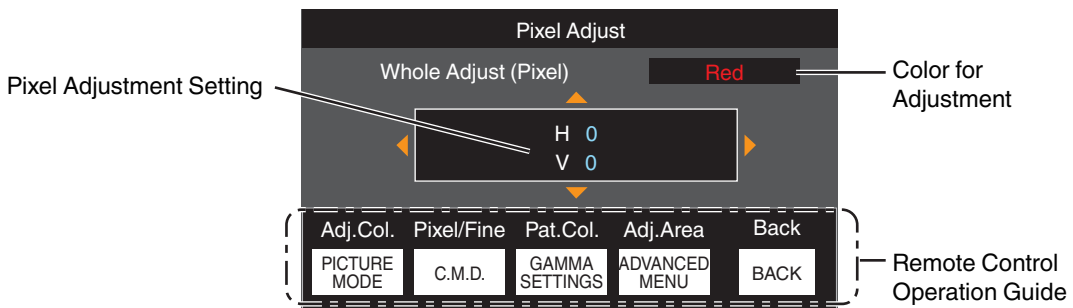

- ⑤ After adjustment is complete, press the [BACK] button twice to exit the Adjustment mode

### Remote Control Operation Guide

Button Name	Function	Description of Operation
[PICTURE MODE]	Adj.Col.	Changes “Adjust Color”.
[C.M.D.]	Pixel/Fine	Switches between “Adjust (Pixel)” and “Adjust (Fine)”. • Switches to “Adjust (Pixel)” when “Adjust Area” is set to “Zone”.
[GAMMA SETTINGS]	Pat.Col.	Changes “Adjust Pattern Color”.
[ADVANCED MENU]	Adj.Area	Switches “Adjust Area”. • A zone cursor appears on the adjustment pattern when the “Zone” setting is selected.



## Whole Adjust (Fine) Operation Procedure

For making general adjustments on the misalignment of the entire screen using “Adjust (Pixel)”, followed by making fine adjustments.

- ① Set “Adjust Area” to “Whole”
- ② Select “Adjust Color” and “Adjust Pattern Color”
- ③ Select Adjust (Fine), and press the [OK] button
  - The Adjustment mode is activated, and the selected adjustment pattern and Fine window are displayed.
  - The adjustable range may be smaller depending on the pixels being adjusted on the entire screen.

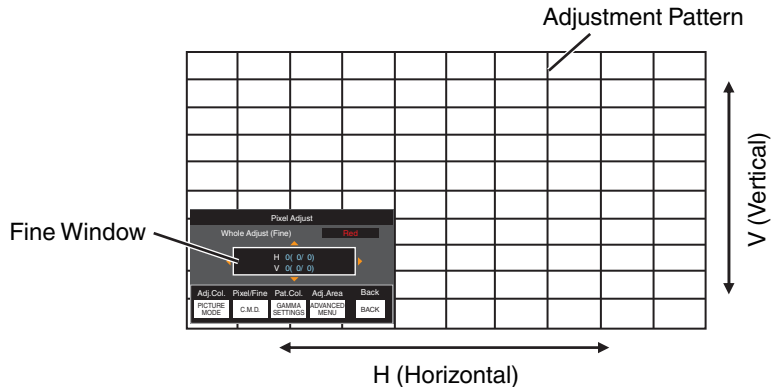

- ④ Use the [ $\blacktriangle$   $\blacktriangledown$   $\blacktriangleleft$   $\blacktriangleright$ ] keys to move and adjust the vertical and horizontal pixels of the entire zone
  - The adjustment setting appears at the center of the Fine window.

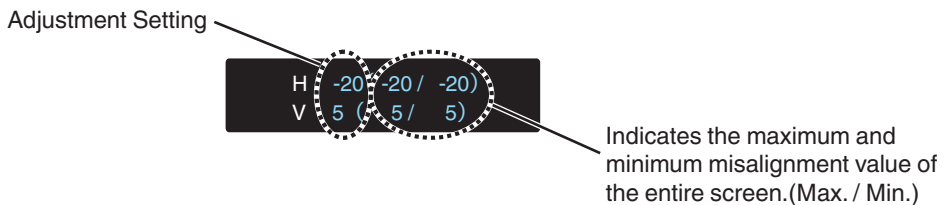
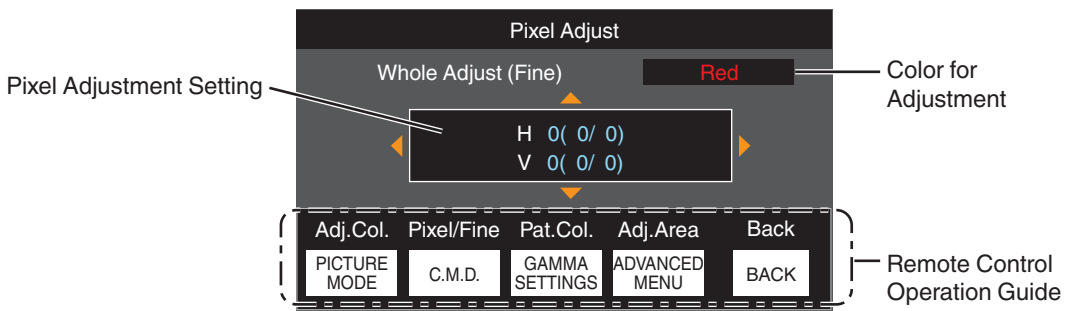

- ⑤ After adjustment is complete, press the [BACK] button twice to exit the Adjustment mode

## MEMO

- If both the maximum overall screen misalignment of H (horizontal direction) and V (vertical direction) are “31”, you cannot select a value that is larger than the displayed setting even when the adjustment setting is lower than the maximum value.
- If the minimum overall screen misalignment is “-31”, you cannot select a value that is smaller than the displayed setting even when the adjustment setting is higher than the minimum value.

## Zone Adjust Operation Procedure

For fine-tuning misalignments on a part of the screen after adjusting the overall screen misalignment using “Adjust (Pixel)” and “Adjust (Fine)”.

- The screen can be divided vertically and horizontally into 10 sections for partial adjustments to be made.
- ① Set “Adjust Area” to “Zone”
  - ② Select “Adjust Color” and “Adjust Pattern Color”
  - ③ Select Adjust (Fine), and press the [OK] button
    - The Adjustment mode is activated, and the selected adjustment pattern and Zone Adjustment window are displayed.
    - The adjustable range may be smaller depending on the pixels being adjusted on the entire screen.

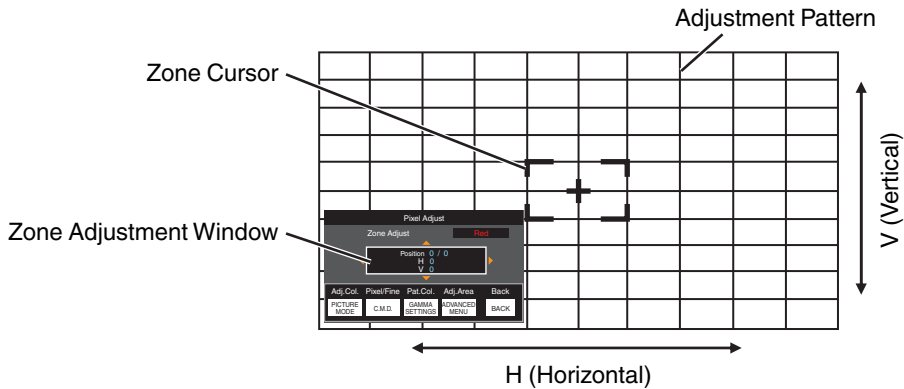

- ④ Press the [▲▼◀▶] keys to move the cursor to the point to be adjusted
- ⑤ Press the [OK] button to enter the Adjustment mode
- ⑥ Use the [▲▼◀▶] keys to move and adjust the vertical and horizontal pixels of the entire zone
  - The adjustment setting appears at the center of the Zone Adjustment window.

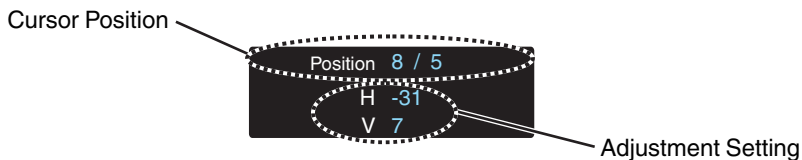
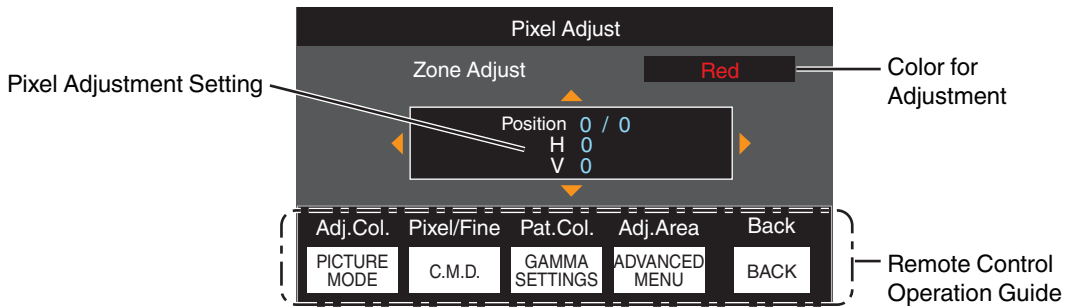

- ⑦ After adjustment is complete, press the [BACK] button twice to exit the Adjustment mode

## Mask

For hiding the peripheral area of the image with a mask (black strip).

Setting	Description
Off	Not masked.
On	Hides the ranges specified in “Top”, “Bottom”, “Left” and “Right” by masking (with black strips).

■ Off



■ On



Mask: black strip around the periphery

## “Top” / “Bottom” / “Left” / “Right”

For specifying the ranges to hide by masking (with black strips).

- Setting range: 0 to 220

## Anamorphic

Configure this setting when an anamorphic lens is used.

Setting	Description
Off	Projects the 2.35:1 image without any changes.
A	Projects the 2.35:1 image with it stretched in the vertical direction only using a 3840 pixel width.
B	Projects the 16:9 image with it compressed in the horizontal direction only.
C	Projects the 2.35:1 image with it stretched in the vertical direction using full 4096 pixel width.

## Screen Adjust

By selecting the optimal correction mode according to the characteristics of the screen in use, corrections can be performed to reproduce natural images with balanced colors.

- ➔ “Setting Screen Correction” (P. 25)

## Installation Style

For setting to “Front”, “Ceiling Mount (F)”, “Rear”, or “Ceiling Mount (R)” according to the installation status of the projector.

- “Front” or “Ceiling Mount (F)” is set when projector is installed in the front with respect to the screen.
- “Rear” or “Ceiling Mount (R)” is set when projector is installed in the rear with respect to the screen.

## Keystone

For correcting any keystone distortion that occurs when the projector is installed at an angle with respect to the screen.

- Vertical setting range: -16 to +16
- \* Increasing the value changes the aspect slightly.
- \* This function cannot be used if “Pincushion” is set.

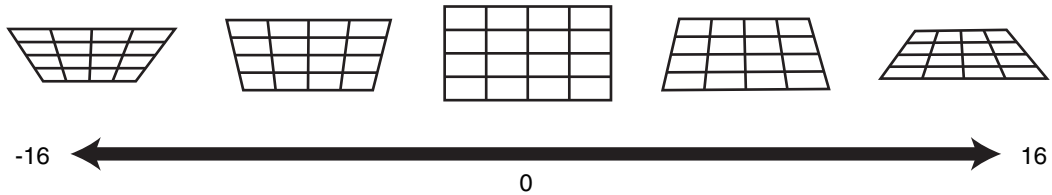

## Pincushion

Corrects the geometric distortion that occurs when projecting on a curved screen.

- Setting range: 0 to 16
- \* When using the projector with the lens shifted in the vertical direction, the amount of distortion at the upper and lower ends may be different and the curvature distortion may not be fully corrected.
- \* This function cannot be used if “Keystone” is set.

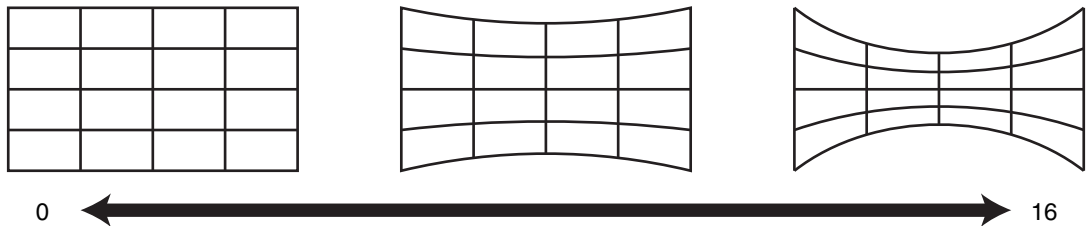

## Aspect

The screen size of the projected image can be adjusted optimally according to the original screen size (aspect) that has been input.

- ➔ “Adjusting the Screen Size (Aspect)” (P. 26)

## Display Setup

### Back Color

For setting the color of the background to “Blue” or “Black” when there is no signal input.

### Menu Position

For setting the display position of the menu.

### Signal Display

For setting the display of the input information to “On” or “Off”.

Setting	Description
Off	Not displayed.
On	Shows the input terminal for 5 seconds when input is switched.

## Logo

For setting the display of logo during startup to “On” or “Off”.

Setting	Description
Off	Not displayed.
On	Displays the “D-ILA” logo for 5 seconds during startup.

## Language

For setting the display language to “English”, “Deutsch”, “Español”, “Italiano”, “Français”, “Português”, “Nederlands”, “Polski”, “Norsk”, “Русский”, “中文”, “繁體中文”, or “日本語”.



## Function

### Trigger

For setting whether to supply a 12 V output to devices such as an external screen equipped with a trigger function.

Setting	Description
Off	No output.
Power	Outputs control signals (12 V) from the trigger terminal when the power is turned on.
Anamo	Outputs control signals when the “Anamorphic” setting is changed from “Off” to a setting other than “Off”. Outputs control signals when the projector is powered on if “Anamorphic” is configured to a setting other than “Off” when the power is turned on.
Inst. Mode 1 to Inst. Mode 10	Outputs control signals when the “Installation Mode” number to be retrieved is the same as the number configured. Outputs control signals when the projector is powered on if the “Installation mode” has the same number as this setting when the power is turned on.

\* When a setting other than “Off” is selected, the control signal output is stopped when the cooling function starts once the power is turned off.

### Off Timer

For setting the duration before the power turns off automatically when the projector is not operated.

• Setting values: “Off”, “1 Hour”, “2 Hours”, “3 Hours” and “4 Hours”

\* The setting will be retained even after the Off Timer operation has completed.

### ECO Mode

Setting	Description
On	Enables “ECO Mode” to minimize power consumption in the Standby mode. <ul style="list-style-type: none"><li>• RS-232C / LAN communication cannot be used in the Standby mode.</li><li>• If there is no signal transmission and operation for 20 minutes while an image is projected, the power management switches the equipment automatically into standby mode.</li></ul>
Off	Select this option to control via RS-232C / LAN communication in the Standby mode or if Control4 is to be used.

\* If this unit enters into standby while “ECO Mode” is set to “On”, all the indicators on the unit including the “STANDBY/ON” indicator are turned off. To turn on the power from this state, use the [STANDBY/ON] button on the unit. Alternatively, press any button on the remote control once to cancel the standby mode then press the [ON] button on the remote control.

## Network

For specifying the settings for external control from a PC or smartphone.

Setting		Description
DHCP Client	On	Obtains the IP address automatically from the DHCP server inside the connected network.
	Off	For configuring the network settings manually.
IP Address		For configuring the IP address.
Subnet Mask		For configuring the subnet mask.
Default Gateway		For configuring the default gateway.
MAC Address		Displays the MAC address of the unit.
Set		Applies the network settings.
Control4 SDDP		Set to "On" to allow Control4 SDDP to detect this unit. When this unit is not connected to an environment under the control of the controller and Control4 SDDP from the Control4 Corporation, set this to "Off".

## Glossary of Network Terminology

- DHCP** : Abbreviation for Dynamic Host Configuration Protocol. This is a protocol for the network to assign an IP address automatically to the connected device.
- IP Address** : Numeric characters for identifying the device that is connected to the network.
- Subnet Mask** : Numeric characters that define the bit count used for the network address that is a segment of the IP address.
- Default Gateway** : Server for communicating beyond the network that is divided by the subnet mask.
- MAC Address** : Abbreviation for Media Access Control address. This is a number that is unique to each network adapter. Each of the network adapters is assigned with a unique MAC address.

## Remote Code

For changing the remote control code.

Setting	Description
A	Change the remote control code from "B" to "A".
B	Change the remote control code from "A" to "B".

- You need to configure the remote control according to the settings of this unit.  
On the remote control unit, press the [MENU] button for three seconds or longer while pressing and hold the [BACK] button to switch the code.
  - The backlight of the remote control blinks 3 times: change the remote control code to "A"
  - The backlight of the remote control blinks 2 times: change the remote control code to "B"
- If the setting differs between this unit and the remote control, the "STANDBY/ON" indicator blinks in green when receiving the remote control code.



## High Altitude Mode

For setting the high altitude mode to “On” or “Off”.

Set to “On” when using the projector at a location of low atmospheric pressure (higher than 900 m (3,000 ft) above sea level).

## Factory Reset

For restoring the settings of this unit to the factory default. However, the following settings will not be reset.

- Gamma data saved in “Gamma” → “Correction Value” → “Import”.
- Color profile data saved in “Color Profile” → “Custom1 to Custom6”.

## Software Update

For performing a software update.

For the latest information on the software, refer to <http://www3.jvckenwood.com/english/download/>.

## Information

Setting	Description
Input	Displays the currently selected video input terminal.
Source (Displayed only during video signal input)	Displays the input source.
Resolution (Displayed only during PC signal input)	Displays the image resolution.
H Frequency	Displays the horizontal frequency.
V Frequency	Displays the vertical frequency.
Color Depth	Displays the color space and color bit depth of the input video signal.
Color Space	<ul style="list-style-type: none"><li>• The color bit depth is not displayed when “YCbCr422” is input.</li><li>• The color bit depth is displayed when color bit depth information is received from the source device.</li></ul>
Colorimetry	Displays the Colorimetry of the input signal.
HDR	Displays the EOTF information when HDR packet is received.
Max CLL/Max FALL	Displays the mastering information of the contents during HDR playback. Max CLL: Maximum Content Light Level Max FALL: Maximum Frame Average Light Level <ul style="list-style-type: none"><li>• The information may not be displayed depending on the player and contents.</li></ul>
Lamp Time	Displays the number of lamp hours used.
Soft Ver.	Displays the firmware version.

# Replacing the Lamp

The lamp is a consumable item. If the image appears dark or the lamp goes out, replace the lamp unit.

- When the lamp replacement time approaches, the user is notified with a message displayed on the screen and by the indicator. (P. 84)

## Lamp Replacement Procedure

### CAUTION

- Do not insert your hands into the lamp compartment. This could cause significant deterioration in the performance of the equipment, or lead to injury and electric shock.
- Do not replace the lamp immediately after the unit has been used. Allow a cooling period of at least one hour before replacement. The temperature of the lamp is still high, and may cause burn injuries.
- Do not subject the lamp unit to shock. Doing so may cause lamp blowout.
- Do not use a flammable air duster to clean the internal parts of the unit. Doing so may cause fire.
- Use only genuine replacement parts for the lamp unit. Also, never attempt to reuse an old lamp unit. Doing so may shorten the lamp life and cause a malfunction.
- Do not touch the surface of a new lamp. Doing so may shorten the lamp life and cause lamp blowout.
- When replacing the lamp, be careful not to injure yourself as the lamp may be broken.
- When replacing the lamp of a projector suspended from the ceiling, work at height is required. This is a dangerous operation. Please consult our service center.

**1** Remove the power plug from the outlet

**2** Remove the lamp cover

- Remove the screw with a ⊕ screwdriver

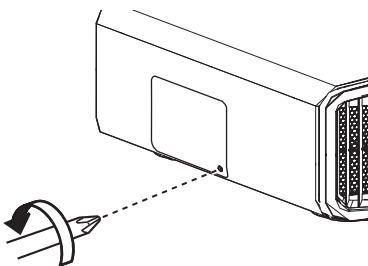

**3** Loosen the screws of the lamp unit

- Loosen the screws with a ⊕ screwdriver.

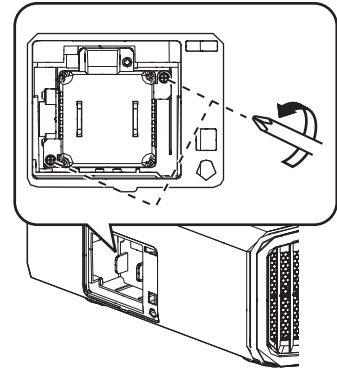

**4** Pull out the lamp unit

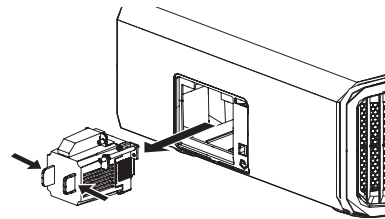

**5** Install the new lamp unit

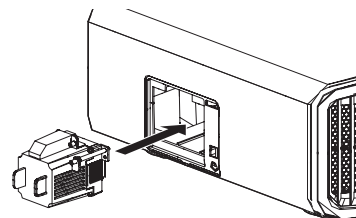



6

## Tighten the screws of the new lamp unit

- Tighten the screws with a ⊕ screwdriver.

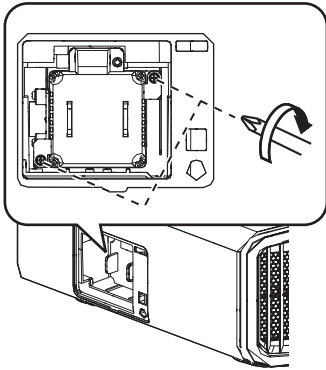

7

## Attach the lamp cover

- Slide the lamp cover from below and ensure that the two tabs at the top of the cover are inserted into the projector unit.

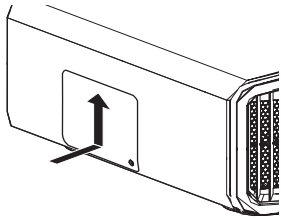

8

## Tighten the screw with a ⊕ screwdriver

- After ensuring that the corner indicated by the circle is properly seated, tighten the screw with a ⊕ screwdriver.

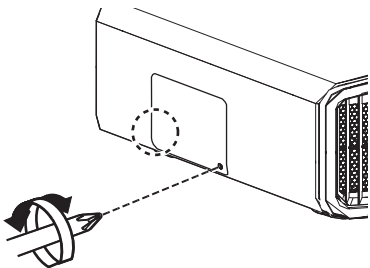

## MEMO

### Usable lamp life

- When the lamp is used with “Lamp Power” set to “Low”, the lamp life on this unit is approximately 4500 hours. This is the average usable time and not a guaranteed value.
- The lamp life may not reach 4500 hours depending on the operating conditions.
- When the lamp has reached the end of its usable life, deterioration progresses rapidly.
- When the video image appears dark, when the color tone looks unnatural, or when the image flickers, replace the lamp unit with a new one promptly.

### Purchasing a lamp unit

For details, please consult your authorized dealer.

- Lamp unit  
Product no.: PK-L2618U
- \* Not suitable for household room illumination.
- \* Lamps with a different product number or those for other projector models cannot be used.

### Information about the lamp

An ultra-high pressure mercury lamp with a high internal pressure is used in the projector.

Due to the characteristics of this lamp, it may blow out with a loud noise or go out when it is subject to shock or after using for a prolonged period of time (the time before the lamp blows out or goes out varies considerably with each lamp as well as the operating conditions).

### After replacing the lamp

- Do not place the removed lamp unit at a place that is within reach by children or anywhere near inflammable items.
- Dispose used lamp units in the same way as fluorescent lamps. Follow the regulations of your local community for disposal.

## Resetting the Lamp Time

Reset the lamp time when you have replaced the lamp. It provides an estimated timing for lamp replacement

### Resetting the lamp time from the menu screen

- 1 Press the [MENU] button to display the menu
- 2 Select “Function”→“Lamp Reset” from the menu

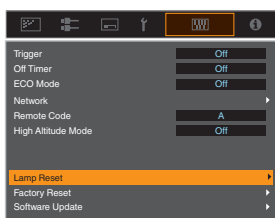

- 3 On the “Reset Lamp Time?” screen, select “Yes” and press the [OK] button

- The lamp time is reset to zero.

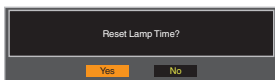

### Resetting the lamp time using the remote control

- 1 Insert the power plug into the power outlet
- 2 Make sure that you operate the remote control in the Standby mode (the power plug is inserted into the outlet, but the power is not turned on)
  - Press the keys according to the sequence of the numbers in the illustration.
  - Make sure that you press a button within two seconds after the last button is pressed. Press the last button for at least two seconds.

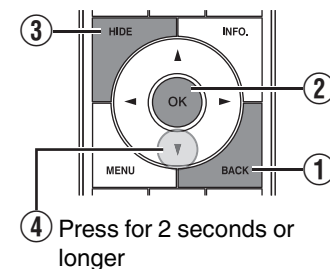

- The “LIGHT” indicator and “STANDBY/ON” indicator blink alternately for three seconds. After that, the unit switches to the Standby mode.

### MEMO

- Reset the lamp time only when you have replaced the lamp.  
If the lamp time is reset while a lamp is in use, you may lose track of the timing for replacing the lamp. Doing so may result in using the lamp beyond the estimated limit, thereby causing lamp blowout.

# Maintaining the Cabinet and Remote Control

- Gently wipe off dirt on the cabinet with a soft cloth.
- If it is extremely dirty, wet a cloth in water, wring dry and use it to wipe off the dirt, followed by wiping again with a dry cloth.
- Pay attention to the following as the cabinet may deteriorate in condition or the paint may come off.
  - Do not wipe with thinner or benzine
  - Do not allow prolonged contact with rubber or plastic products
  - Do not spray volatile chemicals such as insecticide

## Cleaning and Replacing the Filter

Clean the filter regularly. Using a filter without cleaning may reduce the brightness of the image. Dirt that enters the unit may also appear as shadows on the image.

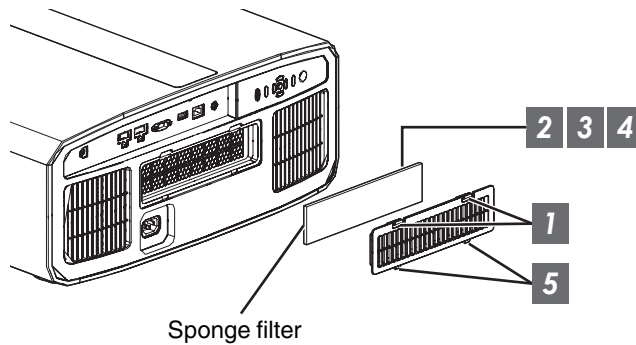

- 1 Press down the two tabs on the cover and pull the cover out to remove the cover
- 2 Remove the sponge filter
- 3 Use a vacuum cleaner to remove dirt from the sponge filter carefully
- 4 Restore the sponge filter
- 5 Insert the catches at the bottom of the cover into the holes on the unit and replace the cover

### MEMO

- If the sponge filter is damaged and needs to be replaced or if dirt has entered the unit, please consult the authorized dealer from which this unit is purchased or any nearby JVC servicing center.
  - \* Be sure to attach the filter. Using this unit without attaching the filter may cause unexpected malfunction.
- Sponge filter  
Product no.: J3K-0094-00

# Troubleshooting

Before sending the unit to your authorized dealer for repair, please check the following points.

The following symptoms are not malfunctions.

**You do not need to worry about the following symptoms if there is no abnormality on the screen.**



- A part of the top or front surface of the unit is hot.
- A creaking sound is heard from the unit.
- An operating sound is heard from the inside of the unit.
- Color smear occurs on some screens.

**This unit is a digital device. This unit may become unable to operate normally due to external static or noise. Perform the following operations when such malfunctions occur.**

- ① If the unit is in the Standby mode, pull out the power plug, followed by inserting it again
- ② Press the /I button on the projector unit to turn on the power again

**When “High Altitude Mode” is set to “On”, and “Lamp Power” is set to “High” during 3D mode, the fan will make louder noise than usual since it is designed to run at high speed in 3D mode.**

## Power is not supplied

Check	Action	Refer to
Is the power cord disconnected?	Insert the power cord (plug) firmly.	P. 21
Is the lamp cover properly shut?	If the unit is in the Standby mode, remove the power plug and close the lamp cover properly. After that, insert the plug again.	P. 64
Is the unit in the Cool-down mode?	After exiting the Cool-down mode, turn on the power again.	P. 23
Is the unit in the Eco mode?	Press the  /I button on the projector unit or the remote control unit. After the “STANDBY/ON” indicator lights up in red, press the  [ON] button.	P. 61

## Power shuts down automatically

Check	Action	Refer to
Has “ECO Mode” been configured?	Set “ECO Mode” to “Off”.	P. 61
Has “Off Timer” been configured?	Set “Off Timer” to “Off”.	P. 61
Are the air inlets and exhaust vent blocked?	Leave proper clearance when installing the unit.	P. 11, 16
Is there a large amount of dirt attached to the sponge filter?	Remove the dirt using a vacuum cleaner.	P. 67

## Video image does not appear

Check	Action	Refer to
Is the correct external input selected?	Select the correct external input terminal.	P. 22
Is the power of the AV device or PC turned on?	Turn on the power of the AV device or PC and play the video.	P. 19
Is the AV device or PC properly connected?	Connect the AV device or PC properly.	P. 19
Are the correct signals being output from the AV device or PC?	Set the AV device or PC properly.	P. 19
Is the cable in use an HDMI-certified cable?	Use an HDMI-certified high-speed cable. Also, use as short a cable as possible.	P. 19
Is an intermediate device (AV amplifier, divider, etc.) in use?	Change the sequence of turning on the source device, intermediate device and the projector. And after turning on each device, ensure that the signal output is stable before turning on the next device.	P. 19
Is an old source device in use?	Change the resolution setting of the source device. For details on how to change the setting, please refer to the instruction manual of the source device. Or, try connecting to the HDMI 2 terminal and set "HDMI 2 EDID" to "B".	P. 52

## 3D images do not appear

Check	Action	Refer to
Do you see two images displayed side by side?	Set "3D Format" to "Side by Side" Video images in the "Side by Side" format may not be recognized automatically in the case of 3D video images.	P. 28
Is an intermediate device (AV amplifier, divider, etc.) in use?	Connect the source device to the projector directly, and check whether there is any improvement in the condition. If the condition improves, it is likely that this is not caused by malfunction of the projector.	P. 19
Is the cable in use an HDMI-certified cable?	Use an HDMI-certified high-speed cable. Also, use as short a cable as possible.	P. 19
Is the power of the 3D Glasses turned on?	If you are using the PK-AG2 or PK-AG3 3D Glasses, turn on the power manually.	Check the instruction manual of the 3D Glasses and 3D Synchro Emitter.
Are the 3D Glasses charged?	Check whether the PK-AG1 battery of the 3D Glasses has run out, and whether PK-AG2 and PK-AG3 are charged.	
Are the 3D Glasses and 3D Synchro Emitter too far away from each other?	Position them at an appropriate distance.	P. 9
Is the 3D Glasses and 3D Synchro Emitter combination correct?	Check the model name of 3D Glasses and 3D Synchro Emitter, and use the correct combination.	

## 3D video image looks unnatural

Check	Action	Refer to
Are there overlapping video images?	If there are overlapping video images partially, this is due to the crosstalk phenomenon. In this case, adjust "Crosstalk Cancel" accordingly.	P. 28
	If there are overlapping video images partially, this is due to the crosstalk phenomenon. This phenomenon often occurs when there are drastic changes in the brightness. In this case, set "Lamp Power" to "High"	P. 46

## Video image looks unnatural

### Colors are unnatural

Check	Action	Refer to
Is the color space of the input signal correctly set?	The color may turn out unnatural when the input signal is different from that in the projector setting. Set the "Color Space" for "Input Signal" correctly.	P. 51
Is the image correctly adjusted?	Adjust "Color" and "Tint" accordingly.	P. 50
Is the AV device or PC properly connected?	Connect the AV device or PC properly.	P. 19

\* The video image may appear slightly reddish immediately after starting up. This is not a malfunction.

### Video image is fuzzy

Check	Action	Refer to
Is the focus correctly adjusted?	Adjust the focus.	P. 24
Is the unit placed too near or too far away from the screen?	Set the unit at a correct distance from the screen.	P. 79

### Video image flickers

Check	Action	Refer to
Do you see horizontally-extended, overlapping video images?	In this case, set "3D Format" to "Auto"	P. 28
Are you viewing the video images under a fluorescent light?	This is caused by interference between the 3D glasses with the flickers of the fluorescent light. View with the fluorescent light turned off.	—
Is "Aperture" set to "Auto 1" or "Auto 2"?	Set "Aperture" to "Manual"	P. 46

### Projected image is dark

Check	Action	Refer to
Is the lamp near exhaustion?	Check the lamp time in the "Information" menu. Prepare a new lamp unit or replace as soon as possible when the lamp is near exhaustion.	P. 63
Is the aperture closed?	Increase the value of the "Aperture" setting.	P. 46
Is "Lamp Power" set to "Low"?	Set "Lamp Power" to "High"	P. 46

### Video image appears horizontally (vertically) extended

Check	Action	Refer to
Is "3D Format" set to "Side by Side"?	Set "3D Format" to "Auto"	P. 28
Is "Anamorphic" set to a setting other than "Off"?	Set "Anamorphic" to "Off"	P. 59

## Striped patterns appear on the screen

Check	Action	Refer to
Does the fabric of the screen have a regular pattern?	Interference fringes may sometimes occur between the fabric pattern and the pixels. Please consult the authorized dealer.	—

## Video images are missing

Check	Action	Refer to
Has screen mask been configured?	Set “Mask” to “Off”.	P. 59

## Remote control does not work

Check	Action	Refer to
Are the batteries correctly loaded?	Match the polarities ( $\oplus$ $\ominus$ ) correctly when loading the batteries.	P. 14
Are the batteries exhausted?	Replace with new batteries.	P. 14
Is there an obstructing object between the remote control and remote sensor?	Remove any obstructing object.	P. 14
Is the remote control held too far away from the unit?	Hold the remote control closer to the sensor during use.	P. 14
Are the IR (infrared) 3D Glasses and 3D Synchro Emitter in use?	As there is a possibility of signal interference, when you are using the IR (infrared) 3D Glasses together with the 3D Synchro Emitter, try adjusting the orientation of the 3D Synchro Emitter.	P. 27

## Noise is heard

Check	Action	Refer to
Is the exhaust vent blocked? Is the unit used near a heater or air-conditioner?	Check the installation condition of the projector. When the surrounding temperature of the projector is high, the fan revolution speed increases to protect the projector unit, hence a louder operating sound.	P. 16
Are you viewing 3D video images?	“Lamp Power” is set automatically to “High” to ease viewing of 3D video images, hence a louder fan operating sound. If you are bothered by the sound, set it to “Low”.	P. 46
Is “Lamp Power” set to “High”?	Setting “Lamp Power” to “High” increases the fan revolution speed, hence the noise becomes louder.	P. 46
Is the “8K e-shift” setting for “MPC” switched? <b>RS3000</b>	This is the sound from the e-shift operation. This is not a malfunction.	—

## There are small black or colored dots on the screen

The D-ILA device is manufactured using high-precision technologies, but there may be some (less than 0.01%) missing pixels or pixels that remain permanently lit. This is not a malfunction.

# When the Following Messages Appear...

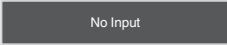
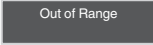
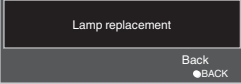
Message	Description	Action
 A dark rectangular screen with the text "No Input" centered in white.	<ul style="list-style-type: none"><li>• No device is connected to the input terminal.</li><li>• The input terminal is connected but there is no signal.</li></ul>	Input the video signals.
 A dark rectangular screen with the text "Out of Range" centered in white.	The video signal input is not supported on this unit.	Input video signals that can be used. (P. 83)
 A dark rectangular screen with the text "Lamp replacement" centered in white. At the bottom right, there is a "Back" label with a small white circle to its left, and "BACK" in white below it.	Indicates that the lamp needs to be replaced soon. To clear the message, press the [BACK] button on the operation panel of the projector unit or the remote control.	Get ready a new lamp unit and replace as soon as possible. Reset the lamp time after replacing the lamp. (P. 64, 66)



# External Control

It is possible to control this unit by connecting it to a PC using an RS-232C cross cable (D-sub 9-pin). The projector can be controlled by connecting it to a PC through the computer network with a LAN cable for control commands to be sent to the projector.

➔ “Network” (P. 62)

- Please use it after you have gained proper understanding from professional books or consulting the system administrator.

## RS-232C Specifications

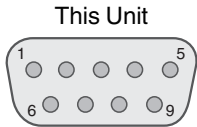

Pin No.	Signal	Function	Signal Direction
2	RxD	Receive data	PC → This unit
3	TxD	Transmission data	This unit → PC
5	GND	Signal ground	—
1, 4, 6 - 9	N/C	—	—

- PC refers to the controller, such as a personal computer.

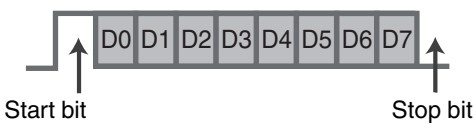

Mode	Non-synchronous
Character length	8 bit
Parity	None
Start bit	1
Stop bit	1
Data rate	19200 bps
Data format	Binary

## TCP/IP Connection

Before controlling via LAN, it is necessary to establish connection of the TCP layer by a “3-way handshake”, followed by sending out “PJREQ” and receiving “PJACK” within five seconds after the projector sends out “PJ\_OK” for connection authentication.

If you are unable to complete sending within five seconds, or when “PJ\_NG” or “PJNAK” is received, check the operating status of the projector, followed by performing the steps again starting from establishment of a TCP connection.

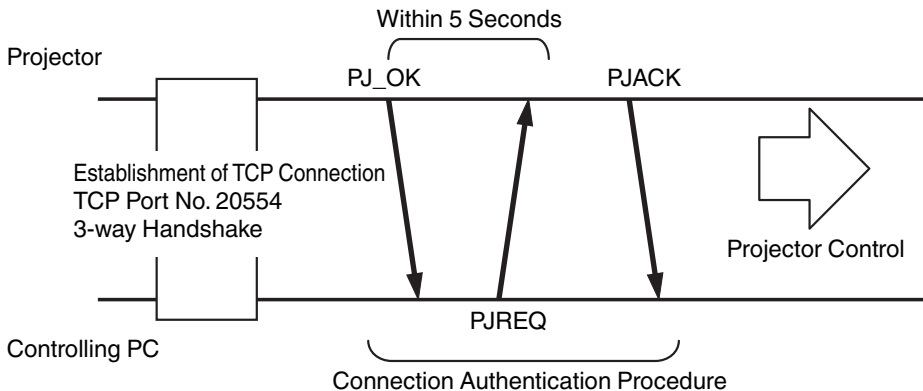

## Command Format

The command between this unit and the computer consists of “Header”, “Unit ID”, “Command”, “Data” and “End”.

- Header (1 byte), Unit ID (2 bytes), Command (2 bytes), Data (n bytes), End (1 byte)

### Header

This binary code indicates the start of communication.

Binary Code	Type	Description
21	Operating command	PC → This unit
3F	Reference command	PC → This unit
40	Response command	This unit → PC
06	ACK	This unit → PC (returns to PC after the command is accepted without error)

### Unit ID

This is a code that specifies the unit. The binary code is fixed at “8901”.

### Command and data

Operating command and data (binary code)

Command	Type	Description
0000	Connection check	Check whether communication is enabled between this unit and the PC during standby.
5057	Power supply	During standby 31: Turns on the power When power is on 30: Turns off the power (Standby mode)
4950	Input	When power is on 36: HDMI 1 37: HDMI 2
5243	Remote control	Sends the same code as the supplied remote control. • “Remote Control Code”P. 75

Reference command and data (binary code)

Command	Type	Description
5057	Power supply	During standby or when power is on 30: Standby mode 31: When power is on 32: In the Cool-down mode 34: When error occurs on this unit
4950	Input	When power is on 36: HDMI 1 37: HDMI 2

### End

This code indicates the end of communication. The binary code is fixed at “0A”.

## Remote Control Code

Binary code is sent during communication.

- The following applies to the case when the remote control code is “A”. In the case of “B”, add “36” to the beginning of the code.

Remote Control Button Name	Binary Code
STANDBY	37 33 30 36
ON	37 33 30 35
INPUT	37 33 30 38
SETTING MEMORY	37 33 43 34
LENS CONTROL	37 33 33 30
HIDE	37 33 31 44
INFO.	37 33 37 34
▲	37 33 30 31
▼	37 33 30 32
▶	37 33 33 34
◀	37 33 33 36

Remote Control Button Name	Binary Code
OK	37 33 32 46
MENU	37 33 32 45
BACK	37 33 30 33
PICTURE MODE	37 33 45 34
COLOR PROFILE	37 33 38 38
GAMMA SETTINGS	37 33 45 35
C.M.D.	37 33 38 41
MPC	37 33 45 30
ADVANCED MENU	37 33 37 33

## Communications Example

This section shows the communication examples of RS-232C.

### Operating command

Type	Command	Description
Connection check	PC → This unit: 21 89 01 00 00 0A This unit → PC: 06 89 01 00 00 0A	Connection check
Power (On)	PC → This unit: 21 89 01 50 57 31 0A This unit → PC: 06 89 01 50 57 0A	When power is turned on from the Standby mode
Power (Off)	PC → This unit: 21 89 01 50 57 30 0A This unit → PC: 06 89 01 50 57 0A	When power is turned off (Standby mode) from power-on mode
Remote control (MENU)	PC → This unit: 21 89 01 52 43 37 33 32 45 0A This unit → PC: 06 89 01 52 43 0A	When the same operation as pressing the [MENU] button on the remote control is performed

### Reference command

Type	Command	Description
Power (On)	PC → This unit: 3F 89 01 50 57 0A This unit → PC: 06 89 01 50 57 0A This unit → PC: 40 89 01 50 57 31 0A	When information on the power-on state is acquired
Input (HDMI 1)	PC → This unit: 3F 89 01 49 50 0A This unit → PC: 06 89 01 49 50 0A This unit → PC: 40 89 01 49 50 36 0A	When information on HDMI 1 input is acquired

# Specifications

Product Name	D-ILA Projector	
Model Name	DLA-RS3000B, DLA-RS2000B, DLA-RS1000B	
Display Panel/Size	D-ILA device *1, 2 0.69" 4K D-ILA (4096 x 2160 pixels) x 3	
Projection Lens	2.0 x power zoom lens, motorized zoom and focus	
Light-source Lamp	265 W ultra-high pressure mercury lamp [product no.: PK-L2618U Average lifespan: 4500 hours ("Low" mode)]	
Screen Size	Approx. 60" to 280" (Aspect ratio of 16:9) <b>RS3000</b> Approx. 60" to 200" (Aspect ratio of 16:9) <b>RS2000</b> <b>RS1000</b>	
Brightness	2200 lm <b>RS3000</b> , 1900 lm <b>RS2000</b> , 1800 lm <b>RS1000</b>	
Projection Distance	Refer to P. 79.	
Input Compatibility Signal	Refer to P. 83.	
Display Resolution	8192 x 4320 pixels <b>RS3000</b> *3, 4096 x 2160 pixels <b>RS2000</b> <b>RS1000</b>	
Input Terminal	HDMI Input	Dual, HDMI 19-pin x 2 (HDCP 2.2-compatible) *4
Output Terminal	Trigger Terminal	Single, Ø 3.5 mm DC Power Jack (⊖ ⊕) DC OUT 12 V, 0.1 A
	3D synchro	Dedicated terminal for 3D Synchro Emitter (single, mini-DIN 3-pin)
Control Terminal	RS-232C Terminal	Single, D-sub 9-pin (male) (external control)
	LAN Terminal	Single, RJ-45 plug, 10BASE-T/100BASE-TX
	Service Terminal	SERVICE Single (USB Type A) *5
Power Requirements	AC 100 V to 240 V, 50 Hz/60 Hz	
Power Consumption	400 W (during normal standby: 1.5 W *6, during Eco Mode standby: 0.3 W *7)	
Operation Environment	Temperature: 5°C to 35°C; humidity: 20% to 80%; storage temperature: -10°C to 60°C	
Installation Height	Below 5,000 ft (1,524 m)	
Dimensions (Width x Height x Depth)	500 mm x 234 mm x 518 mm (19-3/4 in x 9-1/4 in x 20-3/8 in) (including feet) <b>RS3000</b> 500 mm x 234 mm x 495 mm (19-3/4 in x 9-1/4 in x 19-1/2 in) (including feet) <b>RS2000</b> <b>RS1000</b>	
Mass	21.8 kg (48 lb) <b>RS3000</b> , 19.8 kg (43.6 lb) <b>RS2000</b> , 19.6 kg (43.2 lb) <b>RS1000</b>	
Accessories	Refer to P. 9.	

\*1 D-ILA is the abbreviation for Direct Drive Image Light Amplifier.

\*2 D-ILA devices are manufactured using extremely high-precision technology with a pixel effectiveness of 99.99%. Only 0.01% or less of the pixels are either missing or would remain permanently lit.

\*3 During 3D playback, the display resolution is 4096 x 2160 pixels.

\*4 HDCP is the abbreviation for High-bandwidth Digital Content Protection system. The image of the HDMI input terminal may not be displayed in some cases due to changes in the HDCP specifications.

\*5 Exclusively for firmware update.

\*6 The power consumption of this product during networked standby when all wired network ports are connected is 1.5 W.

\*7 "During standby" refers to Eco Mode standby (P. 61).

• Design and specifications are subject to change without prior notice.

• Please note that some of the pictures and illustrations may have been abridged, enlarged or contextualized in order to aid comprehension. Images may differ from the actual product.



**RS3000** has obtained the “THX 4K DISPLAY Certification” determined by THX Ltd. In addition to 2K content, you can also enjoy faithful reproduction of images in a quality as intended by the filmmaker during playback of 4K content.

The THX 4K DISPLAY certification is “an indication of high definition and high resolution”, which is granted to products that have cleared more than 400 image quality tests.



This unit is isf-certified, so calibration can be performed by an isf-certified trainer. After calibration is performed, an isf mode is added to the Picture mode.

For more details, please refer to the isf website.  
<http://www.imagingscience.com/>

## About Trademarks and Copyrights



The terms HDMI and HDMI High-Definition Multimedia Interface, and the HDMI Logo are trademarks or registered trademarks of HDMI Licensing Administrator, Inc. in the United States and other countries.

## Screen Size and Projection Distance

RS3000

Screen Size Diagonal (Inch)	Projection Distance (m)							
	17:9 Screen		16:9 Screen		2.35:1 Screen		4:3 Screen	
	Wide-end	Tele-end	Wide-end	Tele-end	Wide-end	Tele-end	Wide-end	Tele-end
60	1.67	3.43	1.75	3.61	1.86	3.82	2.16	4.44
70	1.96	4.02	2.06	4.23	2.18	4.47	2.54	5.19
80	2.25	4.60	2.37	4.84	2.50	5.12	2.91	5.94
90	2.54	5.19	2.67	5.46	2.83	5.77	3.29	6.70
100	2.83	5.77	2.98	6.07	3.15	6.41	3.66	7.45
110	3.12	6.36	3.28	6.69	3.47	7.06	4.04	8.20
120	3.41	6.94	3.59	7.30	3.79	7.71	4.41	8.95
130	3.70	7.53	3.90	7.92	4.12	8.36	4.79	9.71
140	3.99	8.11	4.20	8.53	4.44	9.01	5.16	10.46
150	4.28	8.70	4.51	9.15	4.76	9.66	5.53	11.21
160	4.58	9.28	4.81	9.76	5.09	10.31	5.91	11.96
170	4.87	9.87	5.12	10.38	5.41	10.96	6.28	12.72
180	5.16	10.45	5.43	10.99	5.73	11.61	6.66	13.47
190	5.45	11.04	5.73	11.61	6.05	12.26	7.03	14.22
200	5.74	11.62	6.04	12.22	6.38	12.91	7.41	14.98
210	6.03	12.21	6.34	12.84	6.70	13.56	7.78	15.73
220	6.32	12.79	6.65	13.45	7.02	14.21	8.16	16.48
230	6.61	13.38	6.96	14.07	7.35	14.85	8.53	17.23
240	6.90	13.97	7.26	14.68	7.67	15.50	-	-
250	7.20	14.55	7.57	15.30	7.99	16.15	-	-
260	7.49	15.14	7.87	15.91	8.32	16.80	-	-
270	7.78	15.72	8.18	16.53	8.64	17.45	-	-
280	8.07	16.31	8.48	17.14	-	-	-	-
290	8.36	16.89	-	-	-	-	-	-
300	8.65	17.48	-	-	-	-	-	-

Screen Size Diagonal (Inch)	Projection Distance (Inch)							
	17:9 Screen		16:9 Screen		2.35:1 Screen		4:3 Screen	
	Wide-end	Tele-end	Wide-end	Tele-end	Wide-end	Tele-end	Wide-end	Tele-end
60	65.5	135.1	69.1	142.2	73.1	150.3	85.2	174.7
70	77.0	158.2	81.1	166.4	85.8	175.8	100.0	204.3
80	88.5	181.2	93.1	190.6	98.5	201.4	114.7	234.0
90	99.9	204.2	105.2	214.8	111.2	227.0	129.5	263.6
100	111.4	227.3	117.2	239.0	123.9	252.5	144.2	293.2
110	122.8	250.3	129.3	263.3	136.7	278.1	158.9	322.9
120	134.3	273.4	141.3	287.5	149.4	303.7	173.7	352.5
130	145.8	296.4	153.4	311.7	162.1	329.2	188.4	382.1
140	157.2	319.4	165.4	335.9	174.8	354.8	203.2	411.8
150	168.7	342.5	177.5	360.1	187.5	380.3	217.9	441.4
160	180.1	365.5	189.5	384.3	200.2	405.9	232.6	471.0
170	191.6	388.5	201.5	408.5	212.9	431.5	247.4	500.7
180	203.1	411.6	213.6	432.8	225.7	457.0	262.1	530.3
190	214.5	434.6	225.6	457.0	238.4	482.6	276.8	559.9
200	226.0	457.6	237.7	481.2	251.1	508.2	291.6	589.6
210	237.4	480.7	249.7	505.4	263.8	533.7	306.3	619.2
220	248.9	503.7	261.8	529.6	276.5	559.3	321.1	648.8
230	260.3	526.8	273.8	553.8	289.2	584.8	335.8	678.5
240	271.8	549.8	285.9	578.0	302.0	610.4	-	-
250	283.3	572.8	297.9	602.2	314.7	636.0	-	-
260	294.7	595.9	309.9	626.5	327.4	661.5	-	-
270	306.2	618.9	322.0	650.7	340.1	687.1	-	-
280	317.6	641.9	334.0	674.9	-	-	-	-
290	329.1	665.0	-	-	-	-	-	-
300	340.6	688.0	-	-	-	-	-	-



Screen size Diagonal (Inch)	Projection Distance (m)							
	17:9 Screen		16:9 Screen		2.35:1 Screen		4:3 Screen	
	Wide End	Tele End	Wide End	Tele End	Wide End	Tele End	Wide End	Tele End
60	1.79	3.66	1.88	3.85	1.99	4.07	2.31	4.73
70	2.09	4.28	2.20	4.50	2.33	4.76	2.70	5.52
80	2.40	4.90	2.52	5.15	2.67	5.44	3.10	6.32
90	2.70	5.52	2.84	5.80	3.00	6.13	3.49	7.11
100	3.01	6.14	3.16	6.45	3.34	6.81	3.88	7.91
110	3.31	6.75	3.49	7.10	3.68	7.50	4.28	8.70
120	3.62	7.37	3.81	7.75	4.02	8.18	4.67	9.49
130	3.92	7.99	4.13	8.40	4.36	8.87	5.06	10.29
140	4.23	8.61	4.45	9.05	4.70	9.56	5.45	11.08
150	4.54	9.23	4.77	9.70	5.04	10.24	5.85	11.88
160	4.84	9.84	5.09	10.35	5.38	10.93	-	-
170	5.15	10.46	5.41	11.00	5.72	11.61	-	-
180	5.45	11.08	5.73	11.65	6.05	12.30	-	-
190	5.76	11.70	6.05	12.30	-	-	-	-
200	6.06	12.32	6.38	12.95	-	-	-	-

Screen Size Diagonal (Inch)	Projection Distance (Inch)							
	17:9 Screen		16:9 Screen		2.35:1 Screen		4:3 Screen	
	Wide-end	Tele-end	Wide-end	Tele-end	Wide-end	Tele-end	Wide-end	Tele-end
60	70.5	144.1	74.0	151.6	78.3	160.2	90.9	186.2
70	82.3	168.5	86.6	177.2	91.7	187.4	106.3	217.3
80	94.5	192.9	99.2	202.8	105.1	214.2	122.0	248.8
90	106.3	217.3	111.8	228.3	118.1	241.3	137.4	279.9
100	118.5	241.7	124.4	253.9	131.5	268.1	152.8	311.4
110	130.3	265.7	137.4	279.5	144.9	295.3	168.5	342.5
120	142.5	290.2	150.0	305.1	158.3	322.0	183.9	373.6
130	154.3	314.6	162.6	330.7	171.7	349.2	199.2	405.1
140	166.5	339.0	175.2	356.3	185.0	376.4	214.6	436.2
150	178.7	363.4	187.8	381.9	198.4	403.1	230.3	467.7
160	190.6	387.4	200.4	407.5	211.8	430.3	-	-
170	202.8	411.8	213.0	433.1	225.2	457.1	-	-
180	214.6	436.2	225.6	458.7	238.2	484.3	-	-
190	226.8	460.6	238.2	484.3	-	-	-	-
200	238.6	485.0	251.1	509.8	-	-	-	-

## Types of Possible Input Signals

### Video

Digital Video Signal		480p 576p 720p 50/60 Hz 1080i 50/60 Hz 1080p 24/25/30/50/60 Hz 2K (2048×1080) 24/25/30/50/60 Hz 4K (3840×2160) 24/25/30/50*/60* Hz 4K (4096×2160) 24/25/30/50*/60* Hz
3D Signal	Frame Packing	720p 50/60 Hz 1080p 24 Hz
	Side-by-side	720p 50/60 Hz 1080p 50/60/24 Hz 1080i 50/60 Hz
	Top-and-bottom	720p 50/60 Hz 1080p 24 Hz

\* When the color space is RGB/YCbCr(4:4:4), only 8-bit input is supported.



### PC signal (HDMI)

Designation	Resolution	fh [kHz]	fv [Hz]	dot CLK [MHz]	Total No. of Dots [dot]	Total No. of Lines [line]	No. of Effective Dots [dot]	No. of Effective Lines [line]
VGA	640×480	31.469	59.940	25.175	800	525	640	480
SVGA	800×600	37.879	60.317	40.000	1056	628	800	600
XGA	1024×768	48.363	60.004	65.000	1344	806	1024	768
WXGA	1280×768	47.776	59.870	79.500	1664	798	1280	768
WXGA	1280×800	49.702	59.810	83.500	1680	831	1280	800
FWXGA	1366×768	47.712	59.790	85.500	1792	798	1366	768
WXGA+	1440×900	55.935	59.887	106.500	1904	934	1440	900
SXGA	1280×1024	63.981	60.020	108.000	1688	1066	1280	1024
WXGA++	1600×900	60.000	60.000	108.000	1800	1000	1600	900
WSXGA+	1680×1050	65.290	59.954	146.250	2240	1089	1680	1050
UXGA	1600×1200	75.000	60.000	162.000	2160	1250	1600	1200
WUXGA	1920×1200	74.556	59.885	193.250	2592	1245	1920	1200

\* Even when signals can be input, video images may not be projected properly depending on the PC or cable in use. When this occurs, switching to another compatible resolution or changing the cable may help to resolve the problem in some cases.

# Indicator Display on the Main Unit

## Meaning of the front panel indicators

-  The indicator is solid.
-  The indicator appears blinking.

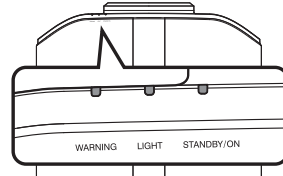

## Operation mode display

Displays using the different colors and solid/blinking light of the indicator on the projector unit.

“STANDBY/ON” lights up (red)  
 • In standby state



“STANDBY/ON” blinking (red)  
 • In the Cool-down mode



“STANDBY/ON” lights up (green)  
 • During lamp startup



“STANDBY/ON” blinking (green)  
 • When the video image is temporarily hidden (HIDE is on)



All lights off  
 • During projection  
 • When in “ECO Mode”



## Estimated timing for lamp replacement

Displays using the solid/blinking light of the “LIGHT” indicator. The “STANDBY/ON” indicator, which shows the operating mode of the unit, is displayed simultaneously as described above.

“LIGHT” lights up (orange)















When lamp replacement is near

## Warning display

You can tell the details of a warning from the (repeated) displays of the “WARNING” and “LIGHT” indicators. The “STANDBY/ON” indicator will light up or appear blinking according to the operation mode of the projector unit. (Please refer to ““Operation mode display”P. 84”.)

The Warning mode is activated once the message is displayed. Projection is interrupted, and the cooling fan is turned on for about 60 seconds.

The power cannot be turned on again while cooling is in progress. Check the following after cooling is complete.

Indicator Status			Blinking Frequency	Description	Check and Countermeasure
WARNING	LIGHT	STANDBY/ON			
 (Red)	 *	 Mode Display	x2	Cooling fan stopped abnormally	<ul style="list-style-type: none"> <li>• Check that nothing is blocking the air inlets.</li> <li>• Check that the external temperature is normal.</li> </ul> Countermeasure: Leave the unit unoperated until it cools down. After that, turn on the power again.
			x3	Internal temperature is abnormally high	
			x4	External temperature is too high	
 (Red)	 (Orange)	 Mode Display	x1	DD board occurs error	
			x2	Motor board occurs error	
			x3	CPU board occurs error	
			x4	Power board occurs error	
 (Red)	 (Orange)	 Mode Display	x1	Lamp does not light up and unit is unable to project	<ul style="list-style-type: none"> <li>• Check that the lamp unit and lamp cover are correctly installed.</li> </ul> Countermeasure: Turn on the power again.
			x2	Lamp goes out during projection	
			x3	When the lamp cover is removed	
 WARNING	 LIGHT	 (Green)	x3	The remote control code differs between this unit and the remote control	Set the remote control code for this unit and the remote control correctly.(P. 62)

If the Warning mode is activated again, wait for the cooling fan to stop, followed by pulling out the power plug from the outlet.

Request for repair at your authorized dealer or a nearby service center.

(\*) If the scheduled time for lamp replacement is exceeded, the indicator may light up.

# Dimensions

(Unit: mm (in))

RS3000

Top Surface

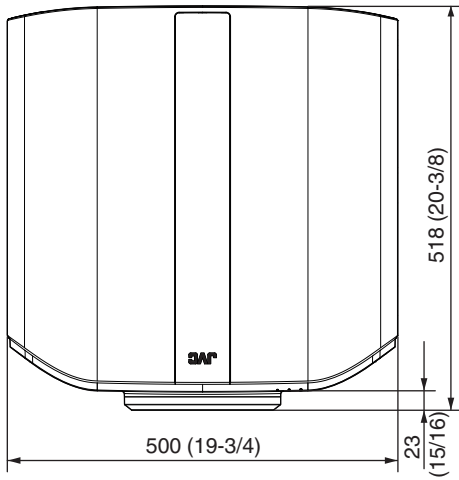

Bottom Surface

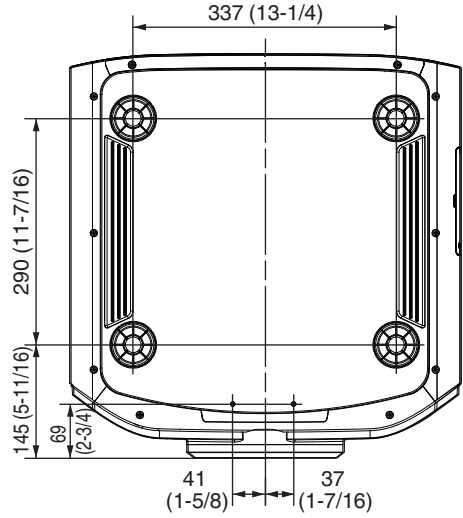

Front

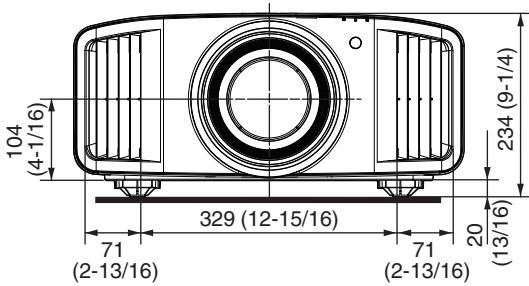

Rear Surface

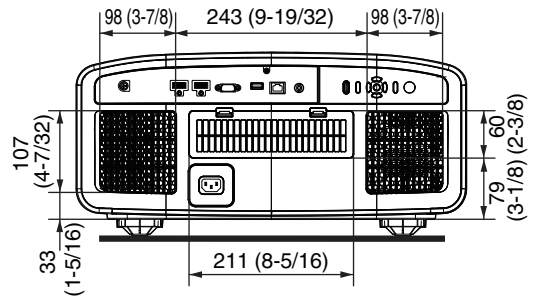

Top Surface

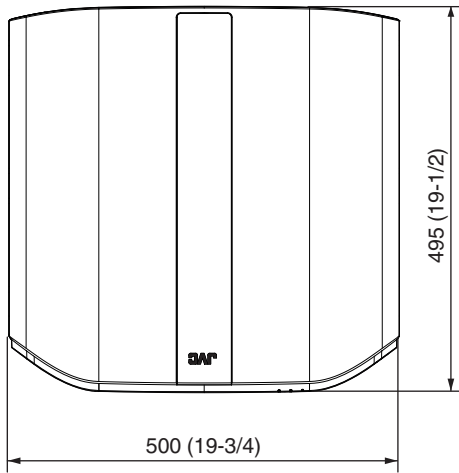

Bottom Surface

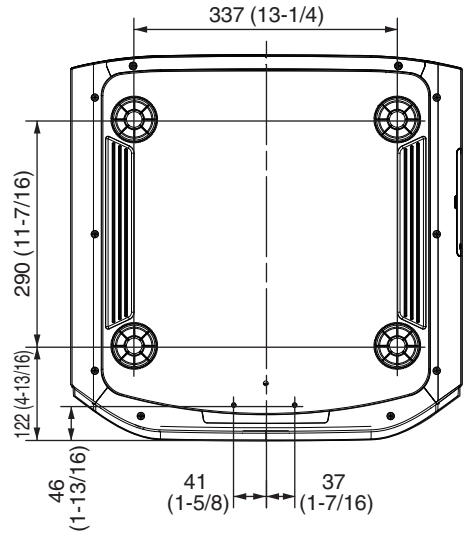

Front

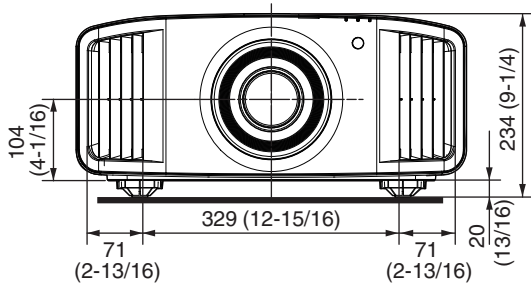

Rear Surface

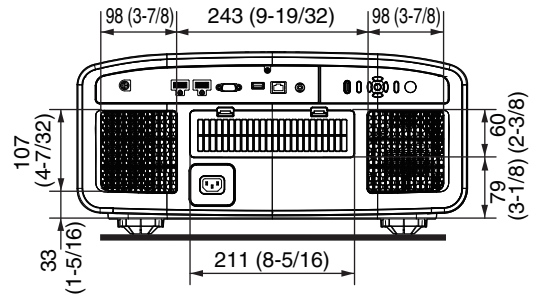

# Index

A	Accessories.....	9	Keystone .....	60	
	Adjusting Distortion of the Projection Screen.....	24	L	Lamp Power.....	46
	Adjusting the Position.....	18		Lamp Reset .....	66
	Adjustments and Settings in the Menu.....	44		Lamp Unit Part Number.....	65
	Anamorphic .....	59		Language Selection.....	61
	Aperture .....	46		Lens.....	10
	Aspect .....	26		Lens Control .....	24, 54
	Auto Tone Mapping .....	40		Lens Cover.....	9
B	Back Color .....	60		List of Menu Items.....	44
	Brightness .....	50		Logo Display.....	61
C	Cleaning and Replacing the Filter.....	67		Low Latency .....	42
	Clear Motion Drive.....	43	M	Maintenance.....	63
	Clear Motion Drive .....	43		Mask .....	59
	Color Management .....	31		Menu.....	15
	Color Profile .....	30		Menu Position .....	60
	Color Space .....	51		Motion Control .....	42
	Color Temp. ....	47		Motion Enhance .....	43
	Color .....	50		MPC.....	35, 50
	Connecting the Projector.....	19	N	Network .....	62
	Contrast .....	50	O	Off Timer .....	61
	Controls and Features.....	10		Optional Accessories.....	9
D	Dark Level / Bright Level .....	38		Original HDR Technology of JVC.....	33
	Dimensions.....	86	P	Partial Adjustment (Zone Adjust).....	55, 58
	Display Setup Menu.....	60		Picture Adjust Menu.....	46
	Distortion Correction.....	60		Picture Mode .....	29, 46
E	Eco Mode.....	61		Picture Tone .....	38
	ECO Mode .....	61		Pixel Adjust .....	55
	External Control.....	73		Power Cord.....	9, 9, 21
F	Factory Reset .....	63		Precautions during Installation.....	16
	Filter Product no.....	67		Projection Distance.....	79
	Focus .....	24	R	Remote Code .....	62
	Frame Interpolation.....	43		Remote Control.....	13
	Function Menu.....	61		Replacing the Lamp.....	64
G	Gamma .....	36, 38	S	Screen Adjust .....	25
H	HDMI Input Level.....	51		Screen Size and Projection Distance.....	79
	HDR Setting .....	52		Securing (Mounting) the Projector.....	17
	High Altitude Mode .....	63		Securing the Projector (Ceiling Mount).....	17
I	Indicator Display.....	84		Shift .....	24
	Information Menu.....	63		Signal Display.....	63
	Input Signal Menu.....	51		Soft Ver. ....	63
	Input Terminal.....	12		Software Update .....	63
	Installation Method.....	16		Specifications.....	77
	Installation Mode .....	53		Signal Display .....	60
	Installation Style .....	59	T	Tint .....	50
	Installation Menu.....	53		Trigger .....	61
				Troubleshooting.....	68



---

Types of Possible Input Signals.....	83
U User Name Edit .....	46
V Viewing 3D Movies.....	27
Viewing HDR Contents.....	33
Viewing Videos.....	22
W When the Following Messages Appear.....	72
Whole Adjust (Fine) .....	55, 57
Whole Adjust (Pixel) .....	55, 56
Z Zoom .....	24
Alphanumeric	
3D Format .....	28
3D Glasses .....	9, 27
3D Setting .....	28
3D Synchro Emitter .....	9, 27





DLA-RS3000  
DLA-RS2000  
DLA-RS1000  
D-LILA PROJECTOR

**JVC**