

4K/UHD 4-Output HDMI to HDBaseT Distribution Amplifier

AT-UHD-CAT-4

User Manual

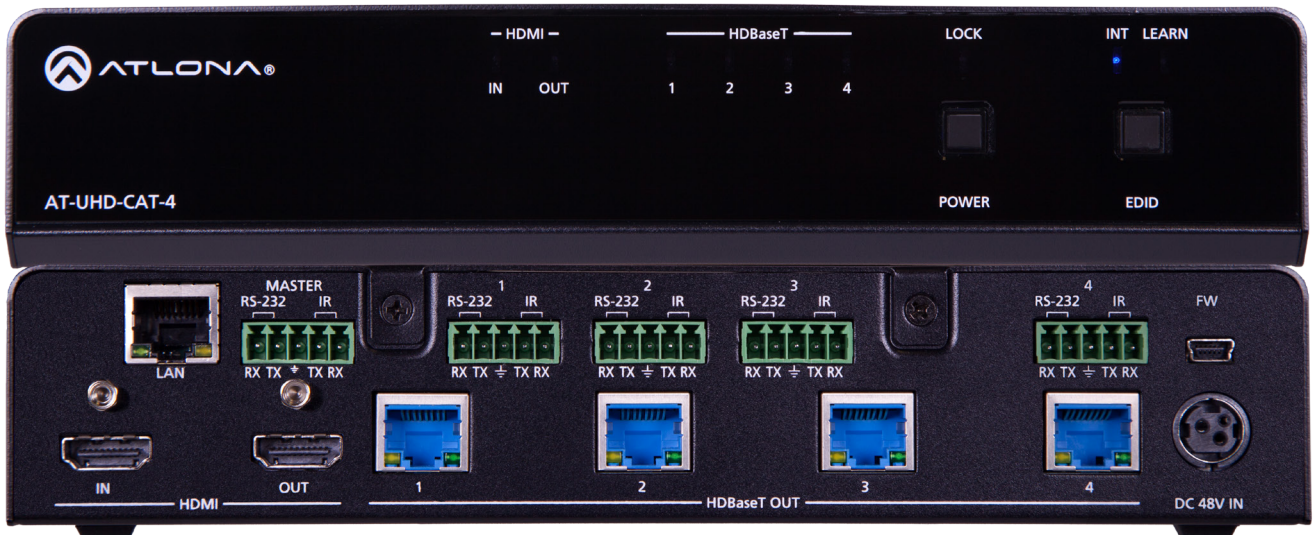

Please check <http://www.atlona.com/product/AT-UHD-CAT-4> for the most recent **firmware update** or **manual**

Table of Contents

1. Introduction	3
2. Package Contents	3
3. Features	3
4. Wall/Rack mounts	3
5. Panel Descriptions	
a. Front Panel	4
b. Back Panel	4
6. Category cable	5
7. TCP/IP and GUI	6-10
8. RS-232	
a. Connection	11
b. Set Up	11
c. Commands	12-13
9. IR	13
10. Connection Diagram	14
11. Control Drivers	14
12. Updating	14
13. Specifications	15
14. Safety	16
15. Warranty	17-18
16. Registration	18

Introduction

The Atlona AT-UHD-CAT-4 is a 4K/UHD HDMI to HDBaseT™ distribution amplifier featuring pass-through HDMI input connections, four HDBaseT outputs and display control capability. Each output transmits AV and control signals up to 230 ft. (70 m) @ 1080p and 130 ft. (40 m) @ 4K/UHD. Features include 4K/UHD @ 60 Hz with 4:2:0 color subsampling, HDCP 2.2 compliance, EDID management, and PoE for powering remote receivers. A wide variety of consumer and commercial displays may be controlled by the AT-UHD-CAT-4 using CEC. Designed for commercial distribution applications, the AT-UHD-CAT-4 is control system-friendly and integrates with any TCP/IP, RS-232, or IR control system and features a 1U, half-rack width enclosure with external, international power supply.

Package Contents

- 1 x AT-UHD-CAT-4
- 5 x Female captive screw connectors (RS-232 and IR)
- 1 x Short rack ear
- 1 x Long rack ear
- 2 x Mounting plates
- 1 x Rubber feet
- 1 x 48V/3.125A DC power supply adaptor
- 1 x User manual

Features

- Supports 4K pass through @ 60Hz 4:2:0 chroma sub-sampling
- Send a single source to multiple displays or UHD-CATs
- Local HDMI output for in room display, AVR, or cascading to another UHD-CAT device
- Provides PoE (Power over Ethernet) to compatible receivers
- Full 3D pass through
- Lossy and lossless audio formats pass through (up to Dolby TrueHD® and DTS-HD Master Audio™)
- HDCP management
- EDID management for better compatibility
- Firmware upgrade via USB or webGUI for easy field service
- Half-rack size
- Comes with rack mount ears and mounting plates

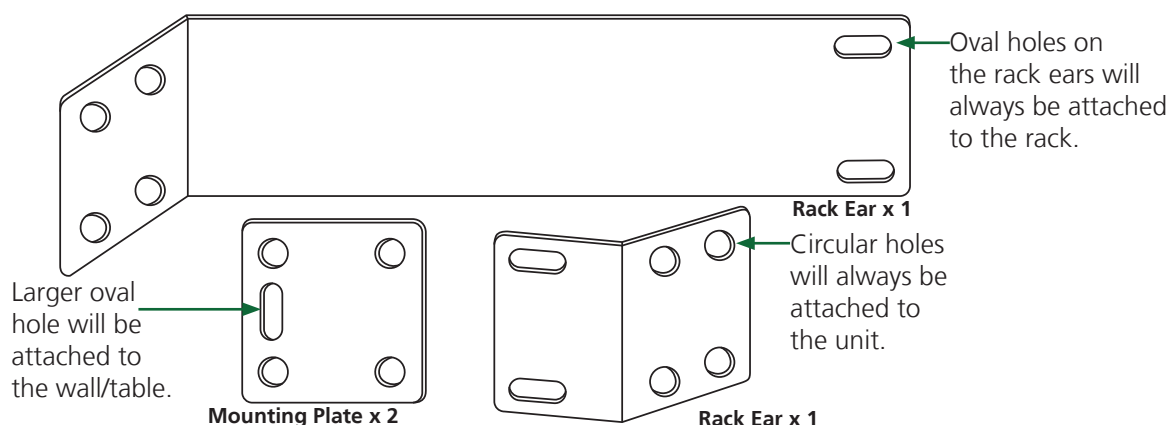

The UHD-CAT can be mounted in three ways: as a single unit in a rack, with a second unit in a rack, or against a wall/table using the mounting plates.

Single unit mounting will use the long rack ear and short rack ear to affix the unit to the rack.

Two unit mounting will use two short rack ears (the second will be in the box with the second unit) and two mountings plates to affix the two units together inside the rack.

Wall/table mounting will use both mounting plates to affix the unit to a table or wall.

Panel Description

Front Panel

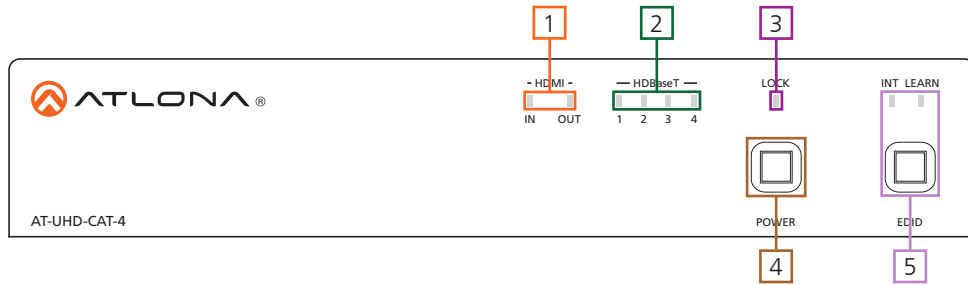

1. HDMI LED - Illuminates when receiving/transmitting signals
2. HDBaseT LEDs - Illuminates when connected to a compatible PoE receiver
3. LOCK LED - Illuminates when buttons are locked
4. Power button - Switch the unit on/off or , when selected within the webGUI or RS-232, the unit and display
5. EDID
LEDs - Lights up to indicate what EDID mode the unit is in
Button - Switches between internal and learned EDID modes

Back Panel

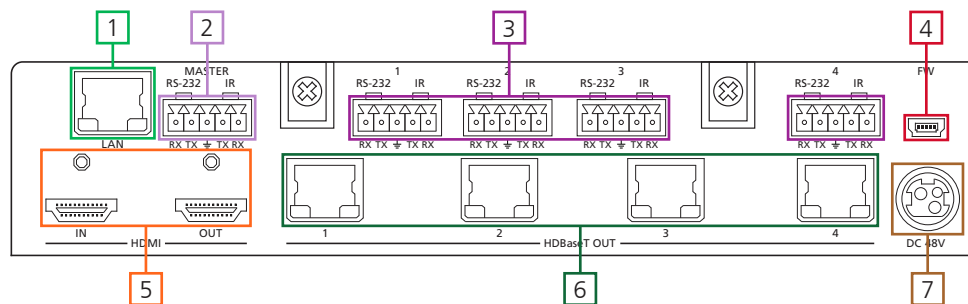

1. LAN port - Connect to network router for control
2. Master control - Connect to PC or control system for unit control
3. RS-232 / IR control ports - Connect to PC or control system for zone control
4. FW port - Connect to a PC for firmware updating
5. HDMI ports - Connect HDMI source and display to these ports
6. HDBaseT OUT ports - Connect HDBaseT PoE receivers to this port (**e.g.** AT-UHD-EX-70C-RX, etc)
Note: Compatible PoE receivers do not need power
7. DC 48V port - Connect included 48V power supply to this port

Category Cable

For the category cables used in the installation of these products, please be sure to use a 568B termination as pictured below:

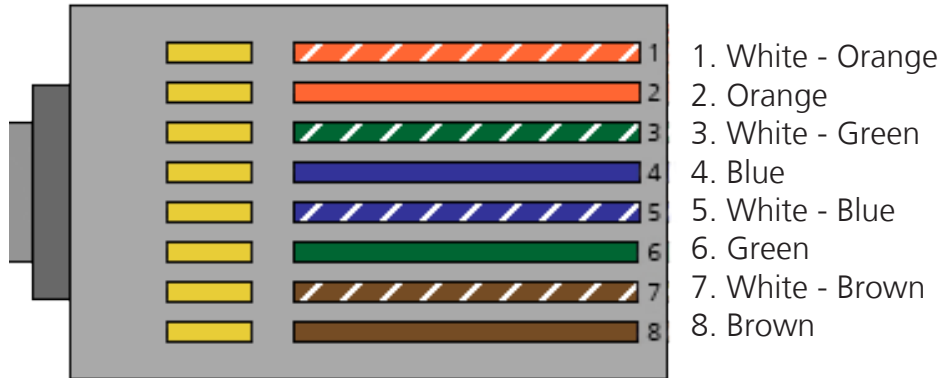

Use the table below to verify the best category cable for the installation.

Performance Rating		Type of LAN cable	
Wiring	Shielding	CAT5e/6	CAT6a/7
Solid	Shielded (STP/FTP)	***	****
	Unshielded (UTP)	**	N/A
Stranded - Patch cable (Not recommended)	Unshielded (UTP)	*	N/A
	Shielded (STP/FTP)	*	N/A
Termination		Please use EIA/TIA-568-B termination	

Important! 4K (UHD) signals are sensitive to cable quality and installation technique. It is recommended to use CAT6a/7 solid core cables for best results.

Note: For cable distances see the specifications on page 15

Connector

Connector type and size is very important to ensure extenders work correctly. Please use the matching cable type with the correct RJ45 connector.

CAT5e cables should use only CAT5e RJ45 connectors

CAT6 cables should use only CAT6 connectors

CAT6a cables should use only CAT6a connectors

CAT7 cables should use only CAT7 connectors

Using the wrong size connectors may result in interference causing loss of signal.

Important! "EZ RJ45 connectors" are not recommended with HDBaseT extenders. Doing so may result in interference with audio and video transmission.

TCP/IP

For convenience, the UHD-CAT comes with DHCP on. This enables the switcher to be connected to a network without concern for overlapping IP addresses with other devices on the network. If your network does not support DHCP, this feature may be turned off and the IP address set using RS-232 commands or the webGUI.

Note: If your system is controlled using IP, it is strongly recommended that you disable DHCP and select a unused IP address so that your system controller doesn't lose contact with the switcher.

TCP/IP WebGUI

Atlona has created an easy to use webGUI for initial setup and later changes to the configuration of the UHD-CAT.

To begin, connect the LAN port of the UHD-CAT to your network. Type the IP address of the UHD-CAT into the web browser of a PC connected to the same network (as seen below).

To find the switcher IP: Use the RS-232 command "IPCFG".

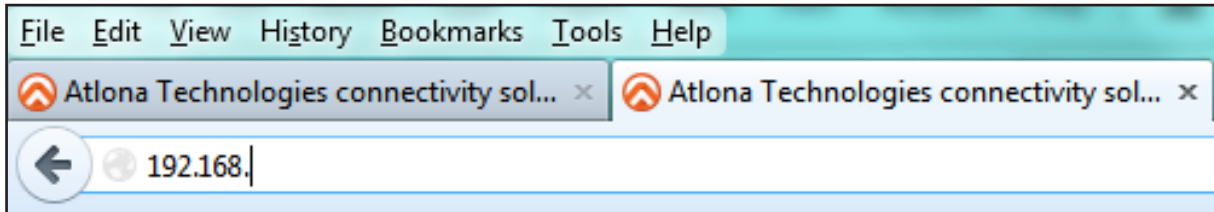

Important: If any stability issues are experienced, disable any anti-virus or firewall that may interfere with network communication to the switcher. Once set up is done and the switcher GUI is no longer being used, the firewall and anti-virus can be re-enabled.

A login form titled "Login" in a dark box. It contains two input fields: "Username" and "Password". Below the fields is a "Submit" button.

A login screen will appear (this is the same log in for admin and general users). For the first log in (and future admin changes) the username is "root" and password is "Atlona".

Note: Only the admin password can be changed (see page 8). The username will always remain "root".

Info

Model Name : AT-UHD-CAT-4
Software Version : V0.0.18
Bootloader Version : V1.11
Output 1 VALENS Version : V1.30.92.1
Output 2 VALENS Version : V1.30.92.1
Output 3 VALENS Version : V1.30.92.1
Output 4 VALENS Version : V1.30.92.1

The home screen tab will display the general system information.

RS-232

RS-232 Parameter Setting

Zone

Baud rate: 115200
 Data bit: 8
 Parity: None
 Stop bit: 1

Save

Console

Baud rate: 115200
 Data bit: 8
 Parity: None
 Stop bit: 1

Save

RS-232 Parameter Setting

Zone -

Adjust the RS-232 parameters of the HDBaseT output of the CAT-4

Console -

Adjust the RS-232 parameters of the CAT-4 to make it compatible with control systems.

Save -

Once the RS-232 parameters are changed, press the save button to make it live on the unit.

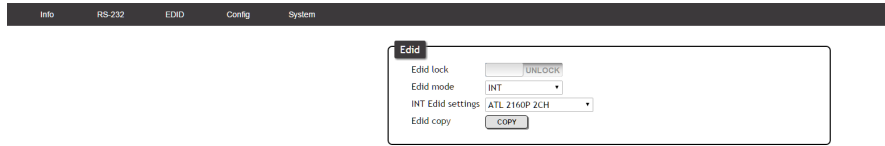

The EDID page enables EDIDs to be selected, copied, and locked.

EDID lock - While locked, EDIDs cannot be switched

EDID mode - Switch between INT and Learn mode

INT EDID settings - Select from drop down INT EDIDs *will grey out when in 'Learn' mode*

EDID copy - Use when in EDID mode 'learn', to copy the EDID of HDBaseT output 1

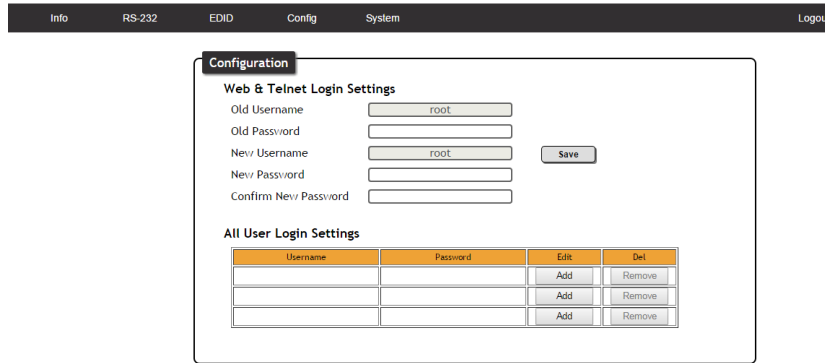

The Configuration Page allows non-admin users to be added or the admin password to be changed.

Only 3 non-admin users can be added. Press the add button. A pop up screen will appear (see below). Fill in the username and password than press save changes. Users will not have the ability to access this page.

Admin password can also be changed. Be sure to write this information down as admin is the only profile allowed to add/remove users.

Note: Default username= "root" and password= "Atlona"

Network

IP Mode: DHCP

IP:

Netmask:

Gateway:

Telnet Port:

Telnet Login Mode

OFF

Telnet Timeout

Broadcast

ON

Network: IP address, netmask, gateway, and telnet port can be set to any settings compatible with your network. The Netmask and Gateway must match your existing network settings

IP Mode -

Static: Set a fixed IP address

Note: For a stable connection when using a control system, it is best to set up a static IP. As you select an IP address, make certain no other devices on your network are using that IP address

DHCP: Dynamic Host Configuration Protocol will automatically select an IP address on the network that is not already in use

Telnet Login Mode - Turn on/off - requires a password to adjust settings

Telnet Timeout - Set the auto log-off time between 1 and 3600 seconds

Broadcast - Turn on and off the feedback through all control ports

System

Power

ON

Lock

UNLOCK

Power button mode

Reset to Default

Firmware Update

No file chosen

Valens Update

No file chosen

Power - Turns the unit on/off

Lock - Locks or unlocks the front panel buttons

Power button mode - Set the power button to turn the device, display (via CEC), or both on/off

Reset to Default - Reset the device to factory settings

Firmware Update - Use this feature to find and load the MCU firmware to the switcher

Note: Firmware can be found and downloaded from <http://www.atlona.com/product/AT-CAT-4/> page under the firmware tab

Valens Update - Use this feature to find and load the Valens firmware to the Valens chips



CEC

Power -

- On: Sends a command over HDBaseT to the HDMI output of the connected receiver to turn the connected display on
- Off: Sends a command over HDBaseT to the HDMI output of the connected receiver to turn the connected display off

Note: Consumer Electronics Control (CEC): Atlona does not guarantee the function of CEC with all televisions. We can confirm proper operation with many current Samsung, Panasonic, and Sony TVs. Many manufacturers do not support the CEC "Off" command when sent from a source and older TVs use proprietary commands. Atlona only supports those TVs that follow CEC command structure from HDMI 1.2a and support the "off" command when issued by a source. We encourage any dealer to get evaluation product from Atlona prior to designing a system around this control technology or be prepared to use other methods to control their displays if Atlona CEC is not compatible with the installed displays.

Note: Together, CEC and HDBaseT output audio control provide a simple solution for complete audio and video control, without the need for IP, RS-232, or spending extra programming time.

RS-232

Connection

RS-232 pin out will be determined by the RS-232 cable and will connect as Rx (receiver), Tx (transmitter), and \perp (ground). (See picture 1)

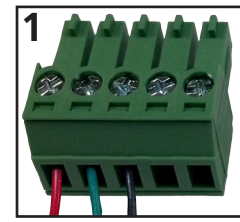
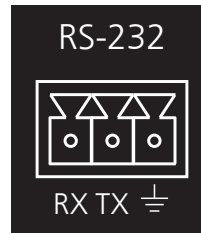

Wire color will differ by cable manufacturer.

RS-232 is often connected through a DB 9-pin to captive screw connector. The pins will have functions associated with them, some will be unassigned.

Note: Typical DB9 connectors use pin 2 for TX, pin 3 for RX, and pin 5 for ground. On some devices functions of pins 2 and 3 are reversed.

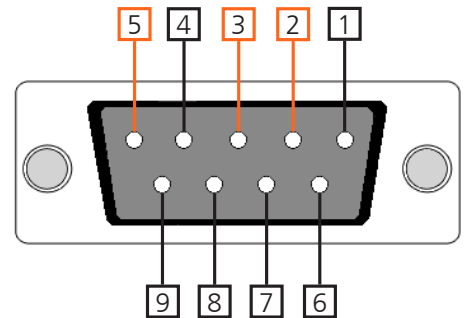

Set Up

To set up the RS-232 hyperterminal (if not using 3rd party software) use the following steps:

1. Connect the CAT-4 to a PC using a 3 pin to USB cable
2. Go to the Device Manager folder (see picture A)
3. Find the CAT-4 COM port and right click with a mouse and select properties (see picture B)
 - Note:** If unsure which COM port is the CAT-4, unplug the cable and plug it back in. It will disappear and reappear on the COM port list.
4. Under the properties menu select the port settings tab and update the menu to the **CAT-4 default settings of:** Bits Per Second: 115200, Data Bits: 8, Parity: None, Stop Bits: 1 and Flow Control: None. (see picture C)

Set up is done and any hyperterminal program may be used to control the CAT-4 now.

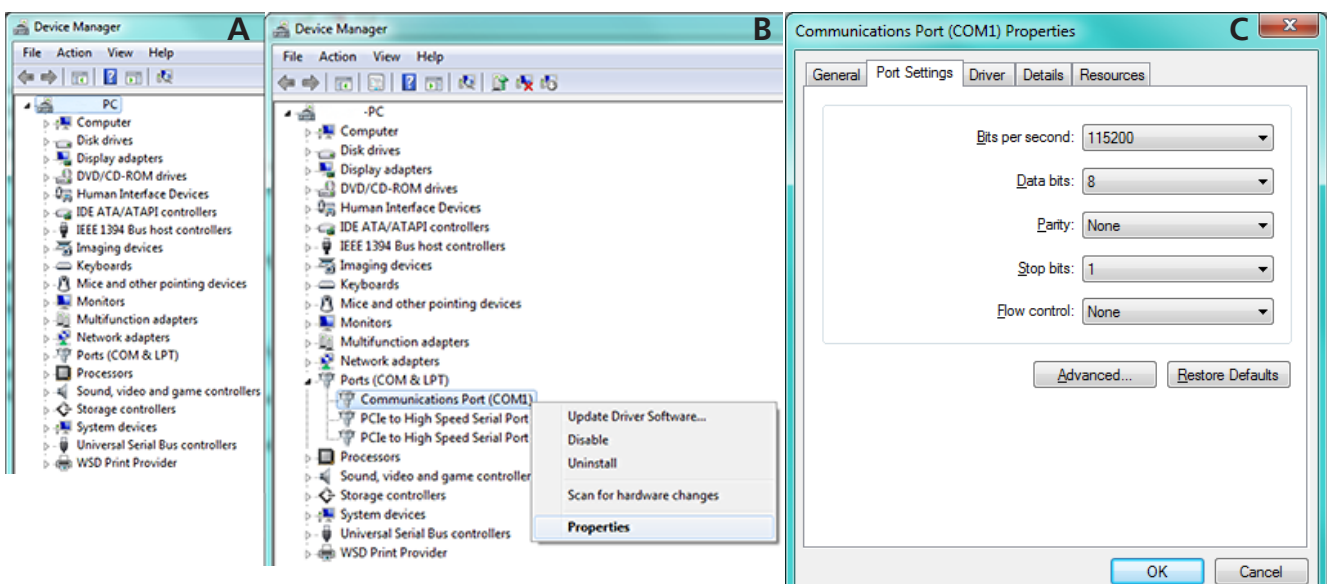

Commands

The command codes are case sensitive, do not change capitalization, spacing, or lettering.

Command	Feedback	Description
PWON	PWON	Power ON
PWOFF	PWOFF	Stand-by
PWSTA	PWON/PWOFF	Get system power status
Type	AT-UHD-CAT-4	Brings up the model information
Version Y e.g. Version boot	Version Y e.g. Version boot	Brings up the software versions firmware [mcu] boot [boot] vtxY [vtxY] rvrxY [rvrxY]
Mreset	Mreset	Reset device to manufacture default
CSpara[Y] e.g. CSpara[38400,8,0,1]	CSpara[Y] e.g. CSpara[38400,8,0,1]	Set RS232 parameter [Y] is the parameters e.g. CSpara[38400,8,0,1]
EDIDSW X e.g. EDIDSW learn	EDIDSW X e.g. EDIDSW learn	Set the EDID mode of the unit
EDIDCopy	EDIDCopy	Copies the EDID of HDBaseT output 1 to memory
EDIDMSet X	EDIDMSet X	Set the Internal EDID X= 0-16, sta
HDCPSet X	HDCPSet X	Switch the EDID reporting between Compliant (on) and non-compliant (off)
Blink	Blink	Will blink an LED on the front of the unit
FWUpdate	FWUpdate	Sets the unit into firmware mode
BCPW X	BCPW X	Set the power button control. X= local (unit), cec (display), both, sta
TrigCECall X	TrigCECall X	Sends the CEC command to all displays X= on, off
TrigCECX Y e.g. TrigCEC2 off	TrigCECX Y e.g. TrigCEC2 off	Send the CEC command to a specific output X= 1-5 (5 is HDMI) Y= on, off e.g. Sends the CEC command to turn HDBaseT output 2 off
Lock	Lock	Locks the front panel
Unlock	Unlock	Unlocks the front panel

Preferred Timings -

0 STD (sink)	1 1080P 2CH	2 1080P Multi CH	3 1080P DD	4 1080P 3D CH
5 1080P 3D Multi CH	6 1080P 3D DD	7 720P 2CH	8 720P DD	9 1280x800 RGB 2CH
10 1366x768 RGB 2CH	11 1080P DVI	12 1280x800 RGB DVI	13 2160P 2CH	14 2160P Multi CH
15 4K420 2CH	16 4K420 Multi CH	sta		

IP Commands

Command	Feedback	Description
IPCFG	IP Addr : x.x.x.x Netmask : x.x.x.x Gateway : x.x.x.x IP Port : x	Displays IP address configure
IPQuit	IPQuit	Telnet Logout
IPAddUser X Y	IPAddUser X Y	IPAddUser [name] [password]. Add user of telnet. If only command write "IPAddUser", it will display all user list. => IPAddUser
IPDelUser Y	IPDelUser Y	IPDelUser [name]. Del user of telnet
IPDHCP Y	IPDHCP Y	IPDHCP [on/off/sta]. Set DHCP mode status and auto reset telnet. e.g. Set DHCP mode is on => IPDHCP on
IPStatic X Y Z	IPStatic X Y Z	IPStatic [Address] [Netmask] [Gateway]. Set static IP address and auto reset telnet. e.g. Set static IP address is 192.168.1.1 255.255.255.0 192.168.1.254 => IPStatic 192.168.1.1 255.255.255.0 192.168.1.254
IPPort Y	IPPort Y	IPPort [port]. Set telnet port and auto reset telnet e.g. Set telnet port 80 => IPPort 80
IPLogin Y	IPLogin Y	IPLogin [on/off/sta]. Set telnet login status. e.g. Set telnet login is on => IPLogin on
Broadcast Y	Broadcast Y	Broadcast [on/off/sta]. Broadcast switch. e.g. Set broadcast mode is on => Broadcast on
IPTimeout Y	IPTimeout Y	IPTimeout [Sec]. Set telnet idle timeout time. Default is 2 minute. e.g. Set telnet idle timeout 10 minutes => IPTimeout 600

Each command is terminated with a carriage return.

Feedback is terminated with a carriage return and line feed.

Note: If the command fails or is incorrect the feedback should be "Command FAILED"

IR

System IR is typically used to connect to control system processors. This input is used to control the UHD-CAT.

Note: The IR receiver is optional for the UHD-CAT. The compatible IR receiver (AT-IR-CS-RX) can be purchased through atlona.com.

The wires of the emitter (TX) and receiver (RX) have been marked to differentiate the pin outs.

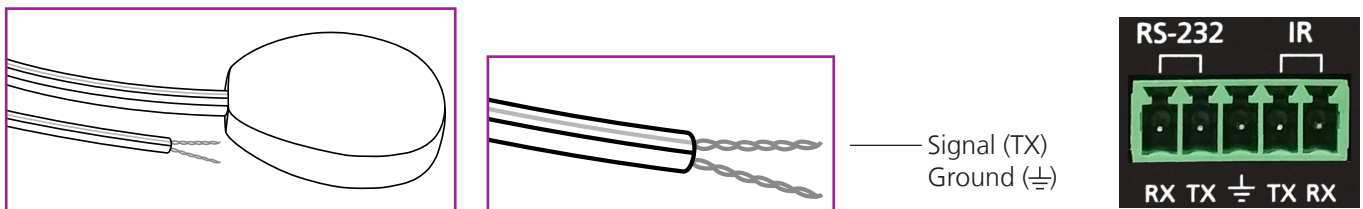

The included IR emitter has two wires: TX and ground. Signal (TX) will have a solid line and ground will be blank.

Connection Diagram

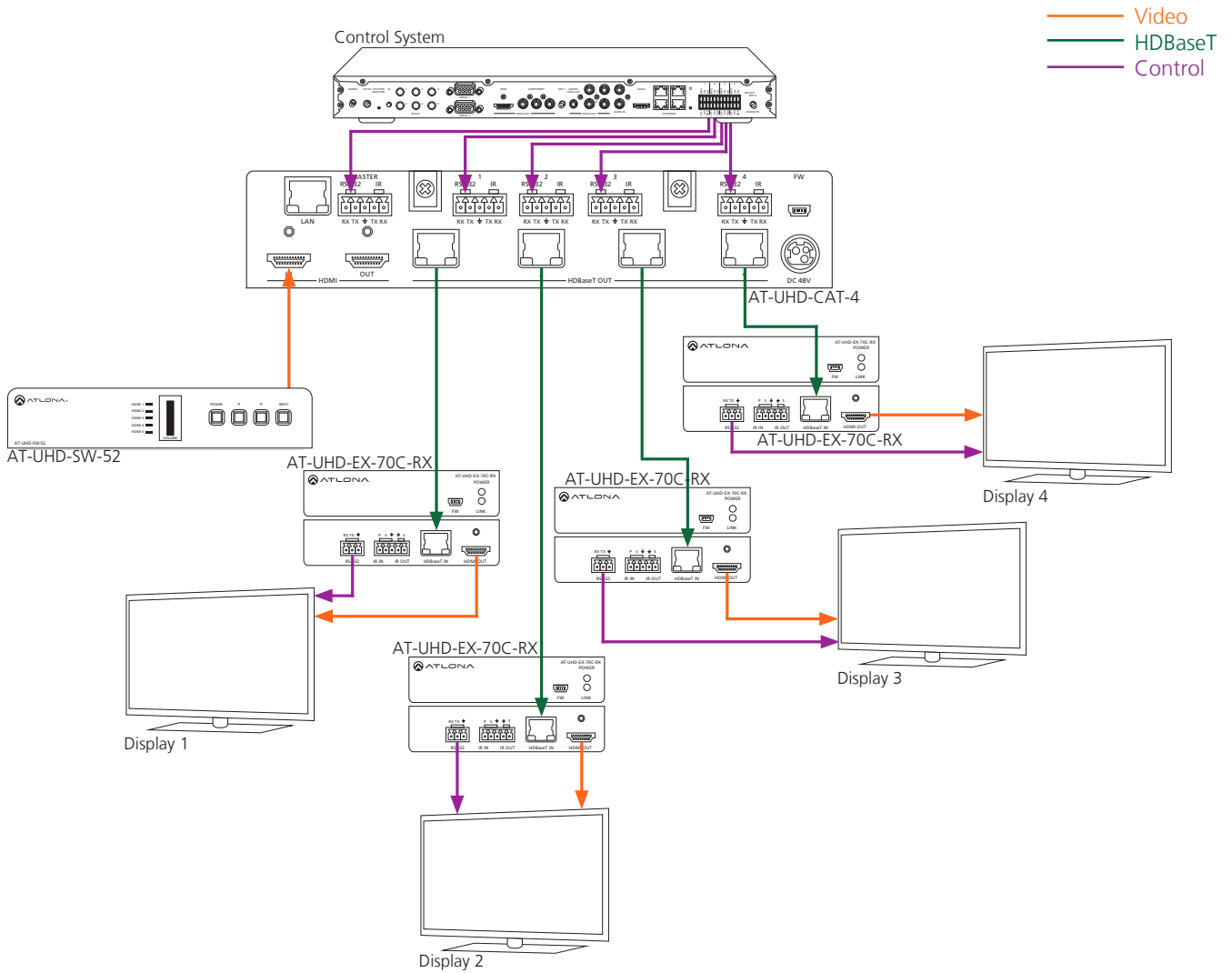

Control Drivers

Visit the **Control Drivers** tab at <http://www.atlona.com/product/AT-UHD-CAT-4/> to download the control drivers for the CAT-4.

CAT-4 Updating

Visit the **Firmware Update** tab at <http://www.atlona.com/product/AT-UHD-CAT-4/> to download the current updates and instructions for the CAT-4 Firmware.

Note: Atlona is constantly improving and updating features and stability. It is recommended that you check to make sure you are on the most current firmware before installation, especially when using a control system.

Specifications

Video Resolutions

Video	4096x2160@24/25/30/50*/60Hz*, 3840x2160@24/25/30/50*/60Hz* (UHD), 2048x1080p, 1080p@23.98/24/25/29.97/30/50/59.94/60Hz, 1080i@50/59.94/60Hz, 720p@50/59.94/60Hz, 576p, 576i, 480p, 480i	
VESA	2560x2048, 2560x1600, 2048x1536, 1920x1200, 1680x1050, 1600x1200, 1600x900, 1440x900, 1400x1050, 1366x768, 1360x768, 1280x1024, 1280x800, 1280x768, 1152x768, 1024x768, 800x600, 640x480	
Color Space	YUV, RGB	
Chroma Subsampling	4:4:4, 4:2:2, 4:2:0	
Color Depth	8-bit, 10-bit, 12-bit	

Audio

HDMI	PCM 2Ch, LPCM 5.1, LPCM 7.1, Dolby Digital, DTS 5.1, Dolby Digital Plus, Dolby TrueHD, DTS-HD Master Audio, Dolby Atmos, DTS:X	
Sample Rate	32kHz, 44.1kHz, 48kHz, 88.2kHz, 96kHz, 176.4kHz, 192kHz	
Bit Rate	up to 24-bit	

Distance

CAT5e/6 @ 4K	up to 35 meters	up to 115 feet
CAT6a/7 @ 4K	up to 40 meters	up to 130 feet
CAT5e/6 @ 1080p	up to 60 meters	up to 197 feet
CAT6a/7 @ 1080p	up to 70 meters	up to 230 feet
HDMI IN/OUT @ 4K	up to 5 meters	up to 15 feet
HDMI IN/OUT @ 1080p	up to 10 meters	up to 30 feet

Signal

Bandwidth	10.2 Gbps	
CEC	Compliant	
HDCP	Compliant 2.2	

Temperature

Operating	0°C to 50°C	32°F to 122°F
Storage	-20°C to 60°C	-4°F to 140°F
Humidity	20 to 90% non-condensing	

Power

Consumption	52.8W	
Idle Consumption	12.54W	
Supply	Input: AC100-240V ~ 50/60Hz Output: DC 48V/3.125A	

Dimension

H x W x D	44 x 222.25 x 261 (mm)	1.73 x 8.75 x 10.28 (inch)
Rack Unit	1/2 rack, 1RU	

Weight

Device	1.66 kg	3.70 lbs
--------	---------	----------

Certification

Unit	CE, FCC	
Power Supply	CE, FCC, Level VI, RoHS, cULus, RCM, CCC	

*4096x2160@50/60Hz & 3840x2160@50/60Hz supported @ chroma subsampling 4:2:0 8-bit only

Safety Information

Safeguards



To reduce the risk of electric shock, do not expose this product to rain or moisture



Do not modify the wall plug. Doing so will void the warranty and safety features.



If the wall plug does not fit into your local power socket, hire an electrician to replace your obsolete socket.



This equipment should be installed near the socket outlet and the device should be easily accessible in the case it requires disconnection.

Precautions

FCC regulations state that any unauthorized changes or modifications to this equipment, not expressly approved by the manufacturer, could void the user's authority to operate this equipment.

Operate this product using only the included external power supply. Use of other power supplies could impair performance, damage the product, or cause fires.

In the event of an electrostatic discharge this device may automatically turn off. If this occurs, unplug the device and plug it back in.

Protect and route power cords so they will not be stepped on or pinched by anything placed on or against them. Be especially careful of plug-ins or cord exit points from this product.

Avoid excessive humidity, sudden temperature changes or temperature extremes.

Keep this product away from wet locations such as bathtubs, sinks, laundries, wet basements, fish tanks, and swimming pools.

Use only accessories recommended by Atlona to avoid fire, shock, or other hazards.

Unplug the product before cleaning. Use a damp cloth for cleaning and not cleaning fluid or aerosols. Such products could enter the unit and cause damage, fire, or electric shock. Some substances may also mar the finish of the product.

Never open, remove unit panels, or make any adjustments not described in this manual. Attempting to do so could expose you to dangerous electrical shock or other hazards. It may also cause damage to your product. Opening the product will void the warranty.

Do not attempt to service the unit. Disconnect the product and contact your authorized Atlona reseller or contact Atlona directly.

Atlona, Inc. ("Atlona") Limited Product Warranty Policy

Coverage

Atlona warrants its products will substantially perform to their published specifications and will be free from defects in materials and workmanship under normal use, conditions and service.

Under its Limited Product Warranty, Atlona, at its sole discretion, will either:

- A) repair or facilitate the repair of defective products within a reasonable period of time, restore products to their proper operating condition and return defective products free of any charge for necessary parts, labor and shipping
- OR**
- B) replace and return, free of charge, any defective products with direct replacement or with similar products deemed by Atlona to perform substantially the same function as the original products
- OR**
- C) refund the pro-rated value based on the remaining term of the warranty period, not to exceed MSRP, in cases where products are beyond repair and/or no direct or substantially similar replacement products exist.

Repair, replacement or refund of Atlona's products is the purchaser's exclusive remedy and Atlona's liability does not extend to any other damages, incidental, consequential or otherwise.

This Limited Product Warranty extends to the original end-user purchaser of Atlona's products and is non-transferrable to any subsequent purchaser(s) or owner(s) of these products.

Coverage Periods

Atlona's Limited Product Warranty Period begins on the date of purchase by the end-purchaser. The date contained on the end-purchaser's sales or delivery receipt is the proof purchase date.

Limited Product Warranty Terms – New Products

- 10 years from proof of purchase date for hardware/electronics products purchased on or after June 1, 2013
- 3 years from proof of purchase date for hardware/electronics products purchased before June 1, 2013
- Lifetime Limited Product Warranty for all cable products

Limited Product Warranty Terms – Refurbished (B-Stock) Products

- 3 years from proof of purchase date for all Refurbished (B-Stock) hardware and electronic products purchased on or after June 1, 2013

Remedy

Atlona recommends that end-purchasers contact their authorized Atlona dealer or reseller from whom they purchased their products. Atlona can also be contacted directly. Visit www.atlona.com for Atlona's contact information and hours of operation. Atlona requires that a dated sales or delivery receipt from an authorized dealer, reseller or end-purchaser is provided before Atlona extends its warranty services. Additionally, a return merchandise authorization (RMA) and/or case number, is required to be obtained from Atlona in advance of returns.

Atlona requires that products returned are properly packed, preferably in the original carton, for shipping. Cartons not bearing a return authorization or case number will be refused. Atlona, at its sole discretion, reserves the right to reject any products received without advanced authorization. Authorizations can be requested by calling 1-877-536-3976 (US toll free) or 1-408-962-0515 (US/international) or via Atlona's website at www.atlona.com.

Exclusions

This Limited Product Warranty excludes:

- Damage, deterioration or malfunction caused by any alteration, modification, improper use, neglect, improper packing or shipping (such claims must be presented to the carrier), lightning, power surges, or other acts of nature.
- Damage, deterioration or malfunction resulting from the installation or removal of this product from any installation, any unauthorized tampering with this product, any repairs attempted by anyone unauthorized by Atlona to make such repairs, or any other cause which does not relate directly to a defect in materials and/or workmanship of this product.
- Equipment enclosures, cables, power supplies, batteries, LCD displays, and any accessories used in conjunction with the product(s).
- Products purchased from unauthorized distributors, dealers, resellers, auction websites and similar unauthorized channels of distribution.

Disclaimers

This Limited Product Warranty does not imply that the electronic components contained within Atlona's products will not become obsolete nor does it imply Atlona products or their electronic components will remain compatible with any other current product, technology or any future products or technologies in which Atlona's products may be used in conjunction with. Atlona, at its sole discretion, reserves the right not to extend its warranty offering in instances arising outside its normal course of business including, but not limited to, damage inflicted to its products from acts of god.

Limitation on Liability

The maximum liability of Atlona under this limited product warranty shall not exceed the original Atlona MSRP for its products. To the maximum extent permitted by law, Atlona is not responsible for the direct, special, incidental or consequential damages resulting from any breach of warranty or condition, or under any other legal theory. Some countries, districts or states do not allow the exclusion or limitation of relief, special, incidental, consequential or indirect damages, or the limitation of liability to specified amounts, so the above limitations or exclusions may not apply to you.

Exclusive Remedy

To the maximum extent permitted by law, this limited product warranty and the remedies set forth above are exclusive and in lieu of all other warranties, remedies and conditions, whether oral or written, express or implied. To the maximum extent permitted by law, Atlona specifically disclaims all implied warranties, including, without limitation, warranties of merchantability and fitness for a particular purpose. If Atlona cannot lawfully disclaim or exclude implied warranties under applicable law, then all implied warranties covering its products including warranties of merchantability and fitness for a particular purpose, shall provide to its products under applicable law. If any product to which this limited warranty applies is a "Consumer Product" under the Magnuson-Moss Warranty Act (15 U.S.C.A. §2301, ET SEQ.) or other applicable law, the foregoing disclaimer of implied warranties shall not apply, and all implied warranties on its products, including warranties of merchantability and fitness for the particular purpose, shall apply as provided under applicable law.

Other Conditions

Atlona's Limited Product Warranty offering gives legal rights, and other rights may apply and vary from country to country or state to state. This limited warranty is void if (i) the label bearing the serial number of products have been removed or defaced, (ii) products are not purchased from an authorized Atlona dealer or reseller. A comprehensive list of Atlona's authorized distributors, dealers and resellers can be found at www.atlona.com.

Atlona, Inc Product Registration

Thank you for purchasing this Atlona product. - We hope you enjoy it and will take an extra few moments to register your new purchase.

Registration creates an ownership record if your product is lost or stolen and helps ensure you'll receive notification of performance issues and firmware updates.

At Atlona we respect and protect your privacy, assuring you that your registration information is completely secure. Atlona product registration is completely voluntary and failure to register will not diminish your limited warranty rights.

To register go to: <http://www.atlona.com/registration>